



# 2N<sup>®</sup> StarGate / 2N<sup>®</sup> StarGate UMTS

2N<sup>®</sup> BlueStar, 2N<sup>®</sup> BlueTower



## User Manual

Version 3.0.1  
Firmware 2.30.02

[www.2n.cz](http://www.2n.cz)

The 2N TELEKOMUNIKACE a.s. joint-stock company is a Czech manufacturer and supplier of telecommunications equipment.



The product family developed by 2N TELEKOMUNIKACE a.s. includes GSM gateways, private branch exchanges (PBX), and door and lift communicators. 2N TELEKOMUNIKACE a.s. has been ranked among the Czech top companies for years and represented a symbol of stability and prosperity on the telecommunications market for almost two decades. At present, we export our products into over 120 countries worldwide and have exclusive distributors on all continents.



2N<sup>®</sup> is a registered trademark of 2N TELEKOMUNIKACE a.s.. Any product and/or other names mentioned herein are registered trademarks and/or trademarks or brands protected by law.



2N TELEKOMUNIKACE administers the FAQ database to help you quickly find information and to answer your questions about 2N products and services. On [faq.2n.cz](http://faq.2n.cz) you can find information regarding products adjustment and instructions for optimum use and procedures „What to do if...“.



#### Declaration of Conformity

2N TELEKOMUNIKACE a.s. hereby declares that the 2N<sup>®</sup> StarGate product complies with all basic requirements and other relevant provisions of the 1999/5/EC directive. For the full wording of the Declaration of Conformity see the CD-ROM enclosed and at [www.2n.cz](http://www.2n.cz).



The 2N TELEKOMUNIKACE company is a holder of the ISO 9001:2000 certificate. All development, production and distribution processes of the company are managed by this standard and guarantee a high quality and advanced technical level of and a professional approach to all of our products.

# Table of Contents

<b>1. Product Overview.....</b>	<b>7</b>
<b>1.1 System.....</b>	<b>8</b>
2N <sup>®</sup> StarGate .....	8
2N <sup>®</sup> BlueStar .....	10
2N <sup>®</sup> BlueTower .....	12
<b>1.2 Product Description .....</b>	<b>16</b>
Basic Features.....	16
Advantages of 2N <sup>®</sup> StarGate/BlueStar/BlueTower .....	16
<b>1.3 Innovations .....</b>	<b>18</b>
<b>1.4 Terms and Symbols Used .....</b>	<b>19</b>
Manual Symbols .....	19
Future Functions.....	19
<b>2. Description and Installation .....</b>	<b>21</b>
<b>2.1 Plug-In Boards .....</b>	<b>22</b>
Basic CPU Board.....	22
Enhanced CPU Board .....	25
AUX Board.....	29
PRI Board .....	32
VoIP Board .....	36
GSM / UMTS Board .....	38
<b>2.2 Antenna and Antenna Splitters .....</b>	<b>44</b>
Antenna Splitter .....	44
Directional Antenna .....	46
Discreet Antenna .....	48
Directional Antenna Connection Cable .....	48
<b>2.3 Gateway Rack Configuration .....</b>	<b>50</b>
<b>2.4 Installation.....</b>	<b>52</b>
Product Completeness Check.....	52
Installation Conditions .....	52
VoIP Connection.....	53
ISDN PRI Connection.....	54
Licence Limitations .....	56
GSM / UMTS Network Restriction.....	57
Basic CPU Firmware .....	57
Potential Problems of GSM / UMTS Networks.....	58
Mounting.....	59
Main Installation.....	60
<b>3. Configuration.....</b>	<b>63</b>

<b>3.1</b>	<b>Important Default Settings .....</b>	<b>64</b>
<b>3.2</b>	<b>Quick Step-by-Step Manual.....</b>	<b>65</b>
	Quick Step-by-Step Manual for ISDN PRI Card.....	65
	Quick Step-by-Step Manual for VoIP Card .....	66
	Quick Step-by-Step Manual for 2N <sup>®</sup> SIM Star.....	67
<b>3.3</b>	<b>System Upgrade.....</b>	<b>69</b>
<b>3.4</b>	<b>Configuration Tool .....</b>	<b>70</b>
	Program Installation .....	70
	Program Running .....	70
	Gateway Connection .....	71
	Main Menu and Button Bar.....	71
	Configuration Menu .....	85
	Off-Line Configuration .....	86
<b>3.5</b>	<b>Enhanced CPU Configuration .....</b>	<b>111</b>
	Serial Console Access .....	111
	Web Browser Access .....	113
<b>3.6</b>	<b>2N<sup>®</sup> External Routing Machine Configuration .....</b>	<b>127</b>
	Installation .....	127
	Configuration .....	129
	ERM Control .....	131
	Description of ERM Function.....	132
	ERM Database Structure .....	132
<b>3.7</b>	<b>2N<sup>®</sup> SIM Star System.....</b>	<b>135</b>
	Product Purpose.....	135
	2N <sup>®</sup> SIM Star Key Components .....	135
	SIM Client Configuration .....	135
<b>3.8</b>	<b>Voice CallBack Centre Configuration .....</b>	<b>136</b>
	Function Scheme .....	136
	Installation and Licences .....	137
	Configuration .....	141
<b>4.</b>	<b>Advanced Configuration .....</b>	<b>143</b>
<b>4.1</b>	<b>List of AT Commands .....</b>	<b>144</b>
	<b>Basic Commands .....</b>	<b>144</b>
	<b>Configuration commands .....</b>	<b>144</b>
<b>4.2</b>	<b>List of Status Codes.....</b>	<b>150</b>
<b>4.3</b>	<b>Trace .....</b>	<b>155</b>
<b>4.4</b>	<b>List of LOG Events .....</b>	<b>157</b>
<b>4.5</b>	<b>Statistics.....</b>	<b>159</b>
<b>4.6</b>	<b>CDR Line Description .....</b>	<b>160</b>

<b>5.</b>	<b>Technical Parameters .....</b>	<b>161</b>
5.1	StarGate Technical Parameters .....	163
5.2	BlueStar Technical Parameters .....	165
5.3	BlueTower Technical Parameters.....	167
<b>6.</b>	<b>Supplementary Information .....</b>	<b>169</b>
6.1	Regulations and Directives .....	170
6.2	Troubleshooting .....	171
6.3	List of Abbreviations.....	173
6.4	General Instructions and Cautions .....	175



# 1

# Product Overview

In this section, we introduce the **2N® StarGate / BlueStar / BlueTower** product, outline its application options and highlight the advantages following from its use. This section also includes safety instructions.

Here is what you can find in this section:

- System
- Product Description
- Innovations
- Terms and Symbols Used

# 1.1 System

This user manual is designed for three types of gateways. All the gateways have the same features and differ in the maximum capacity of the GSM / UMTS channels used.

## 2N<sup>®</sup> StarGate

### Basic Dimensions

2N<sup>®</sup> StarGate is the biggest GSM gateway in the 2N<sup>®</sup> PRI gateways family. The system is integrated in a 19" subrack of the height of 3U and depth of 360mm. The front side is open, equipped with slots for plug-in boards with front panels. The panel includes the main switch. In case not all GSM / UMTS cards are plugged in, the vacant front section must be covered with a fixed panel(s).

The whole backside is covered with a panel with a built-in active fan, which is automatically switched on whenever the power supply temperature exceeds 70°C. The main power supply unit is located in front of the fan. The bottom and upper sides are covered by perforated sheet and the assembly flanges are provided with handrails.

The system bus is designed as a printed circuit board (PCB) with DIN connectors and fitted to the inner subrack carrier profiles.

### Front Side Division

The subrack width is divided into an 8HP-wide mains panel and 19x4HP-wide modules in the following sequence (from right to left):

VoIP version	
Fixed panel with a main switch (AC type) or power connectors (DC type)	8HP
VoIP card	4HP
Basic or enhanced CPU card	4HP
AUX card	4HP
GSM or UMTS cards (one for two GSM / UMTS channels)	Remaining space (each 4HP)

ISDN PRI version	
Fixed panel with a main switch (AC type) or power connectors (DC type)	8HP
Basic or enhanced CPU card	4HP
AUX card	4HP
1ISDN PRI or 2ISDN PRI card	4HP
GSM or UMTS cards (one for two GSM / UMTS channels)	Remaining space (each 4HP)



## Examples of Used Types

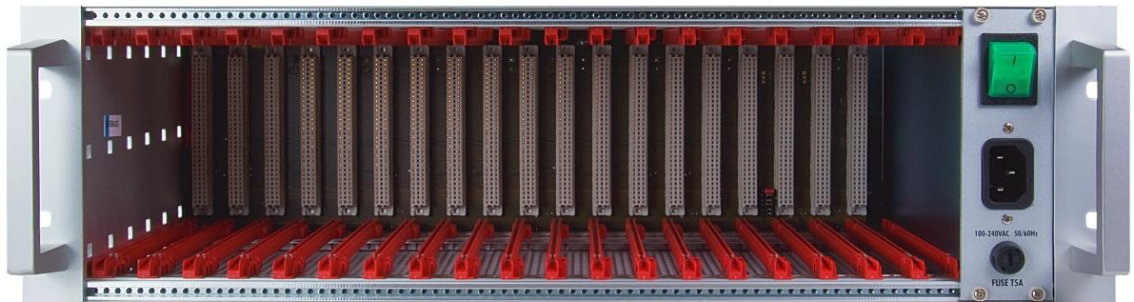

Empty 2N® StarGate Rack



2N® StarGate with 16 GSM Boards, Basic CPU, VoIP Interface and AC Power Supply



2N® StarGate with 16 UMTS Boards, Enhanced CPU, 2 ISDN PRI Interfaces and AC Power Supply



### Note

- Please keep all cards in the right positions. Wrong positions will cause malfunction of the whole system!
- In the case of VoIP card replacement by ISDN PRI (and vice versa) please read the instructions in Section 2 – Installation.

---

## Power Supply

---

The system uses an industrial power supply unit with natural cooling and an auxiliary external fan, which is switched on automatically whenever the power supply temperature exceeds 70°C. The power supply unit is designed with a 30% reserve even under the maximum load.

### Power supply types

Internal 90-260V / 50 – 60 Hz (output 5V / 30A);

Internal 48 DC (output 5V / 30A).

The type of the power supply unit to be used depends on the part number.



### Caution

- Make sure that the incoming supply is matching the requested values!
- High voltage may cause a serious injury or death!



### Tip

- You are recommended to connect the gateway to the UPS system.

---

## 2N<sup>®</sup> BlueStar

---

---

### Basic Dimensions

---

2N<sup>®</sup> BlueStar is a GSM gateway from the 2N<sup>®</sup> PRI gateway family with the capacity up to 16 GSM / UMTS channels. The system is integrated in a 19" subrack of the height of 3U and depth of 360mm. The front side is open, equipped with slots for plug-in boards with front panels. The panel includes the main switch. In case not all GSM / UMTS cards are plugged in, the vacant section of the front side must be covered with a fixed panel(s). An optional antenna splitter can be installed.

The whole backside is covered with a panel with a built-in active fan, which is automatically switched on in case the power supply temperature exceeds 70°C. The main power supply unit is located in front of the fan. The bottom and upper sides are covered by perforated sheet and the assembly flanges are provided with handrails.

The system bus is designed as a printed circuit board (PCB) with DIN connectors and fitted to the inner subrack carrier profiles.

## Front Side Division

The subrack width is divided into an 8HP-wide mains panel and 19x4HP-wide modules in the following sequence (from right to left):

### VoIP version

Fixed panel with a main switch (AC type) or power connectors (DC type)	8HP
VoIP card	4HP
Basic or enhanced CPU card	4HP
AUX card	4HP
GSM or UMTS cards (one for two GSM / UMTS channels)	Remaining space (each 4HP)

### ISDN PRI version

Fixed panel with a main switch (AC type) or power connectors (DC type)	8HP
Basic or enhanced CPU card	4HP
AUX card	4HP
1ISDN PRI or 2ISDN PRI card	4HP
GSM or UMTS cards (one for two GSM / UMTS channels)	Remaining space (each 4HP)

## Examples of Used Types



2N® BlueStar 8 GSM Boards, Basic CPU, 2 ISDN PRI Interfaces, Integrated Antenna Splitter and AC Power Supply



### Note

- Please keep all cards in the right positions. Wrong positions will cause malfunction of the whole system!
- In the case of VoIP card replacement by ISDN PRI (and vice versa) please read the instructions in Section 2 – Installation.

## Power Supply

The system uses an industrial power supply unit with natural cooling and an auxiliary external fan, which is switched on automatically whenever the power supply temperature exceeds 70°C. The power supply unit is designed with a 30% reserve even under the maximum load.

### Power supply types

Internal 90-260V / 50 – 60 Hz (output 5V / 30A)

Internal 48 DC (output 5V / 30A)

The type of the power supply used depends on the part number.



### Caution

- Make sure that the incoming supply is matching the requested values!
- High voltage may cause a serious injury or death!



### Tip

- You are recommended to connect the gateway to the UPS system.

## 2N<sup>®</sup> BlueTower

### Basic Dimensions

2N<sup>®</sup> BlueTower is the smallest of the 2N<sup>®</sup> PRI gateway family, featuring the capacity up to 8 GSM / UMTS channels. The system is integrated in a small 19" subrack of the height of 3U, width of 29HP and depth of 320mm. The front side is open, equipped with slots for plug-in boards with front panels. The panel includes the main switch. In case not all GSM / UMTS cards are plugged in, the vacant section of the front side must be covered with a fixed panel(s). An optional antenna splitter can be installed.

The whole backside is covered with a panel with a built-in safety-fuse box and power socket. The main power supply unit is inside the system and is fully designed for passive cooling. The bottom and upper sides are covered with EMC sheet.

The system bus is designed as a printed circuit board (PCB) with DIN connectors and fitted to the inner subrack carrier profiles.

### Front Side Division

The subrack width is divided into 7x4HP-wide modules in the following sequence (from right to left):

VoIP version

VoIP card

4HP

Basic or enhanced CPU card	4HP
AUX card	4HP
GSM or UMTS cards (one for two GSM / UMTS channels)	Remaining space (each 4HP)
<b>ISDN PRI version</b>	
Basic or enhanced CPU card	4HP
AUX card	4HP
1ISDN PRI or 2ISDN PRI card	4HP
GSM or UMTS cards (one for two GSM / UMTS channels)	Remaining space (each 4HP)

### Examples of Used Types



2N® BlueTower with 2 UMTS Boards, Enhanced CPU, VoIP Interfaces and Integrated

## Antenna Splitter



2N® BlueTower with 2 UMTS Boards, Basic CPU, 2 ISDN PRI Interfaces and Integrated Antenna Splitter

**Note**

- Please keep all cards in the right positions. Wrong positions will cause malfunction of whole system!
- In the case of VoIP card replacement by ISDN PRI (and vice versa) please read the instructions in Section 2 – Installation.

---

## Power Supply

---

The system uses an industrial power supply unit with natural cooling and an auxiliary external fan, which is switched on automatically whenever the power supply temperature exceeds 70°C. The power supply unit is designed with a 30% reserve even under the maximum load.

**Power supply types**

Internal 90-260V / 50 – 60 Hz (output 5V / 30A);

Internal 48 DC (output 5V / 30A).

The type of the power supply used depends on the part number.

**Caution**

- Make sure that the incoming supply is matching the requested values!

- High voltage may cause a serious injury or death!

**Tip**

- You are recommended to connect the gateway to the UPS system.



# 1.2 Product Description

## Basic Features

---

2N<sup>®</sup> StarGate / BlueStar / BlueTower is a compact yet highly sophisticated system. It supports full remote supervision and configuration via an IP network or using an external modem over a BRI-ISDN and analogue line, or over a B channel in a PRI-ISDN trunk. The system has been designed and works with a lot of highly sophisticated functions, which make it fully client-oriented and highly reliable in cooperation with both GSM networks and ISDN. In addition, it provides full monitoring and comfortable (web interface) configuration without functional limitations. Configuration alterations can be made without resetting, i.e. under full operation. Hot-swappable plug-in GSM / UMTS boards, which can be swapped under full operation including SIM cards, are a matter of course. The use of up to eight SIM cards per GSM / UMTS module in combination with an intelligent SIM card switching tool and detailed statistics upgrade this system into a powerful LCR tool. There is also support of remote SIM cards (2N<sup>®</sup> SIM Star) and an external LCR machine (2N<sup>®</sup> External Routing Machine). High product stability is achieved by the fact that the gateway is programmed in the ASM, i.e. an OS-FREE system. Two independent 30MHz Philips microprocessors provide an error-free operation, high speed, automatic fault detection and easy upgrade. The system also features easy installation, simple operation and easy replacement of defective parts as it is composed of plug-in boards that communicate independently along system buses. As already mentioned, the system allows for an easy detection of defective parts, automatic locking against use and easy replacement (hot-swap). Thanks to the above- mentioned properties, the system can be installed and configured successfully within one hour!

## Advantages of 2N<sup>®</sup> StarGate/BlueStar/BlueTower

---

- Compact size, modularity and hot-swappable solution;
- Up to 32 GSM / UMTS modules (16 in BlueStar, 8 in BlueTower);
- Up to 256 SIM cards in a system (StarGate);
- Worldwide use – GSM / UMTS boards support all standard GSM (850/900/1800/1900MHz) and UMTS (850/1900/2100MHz) bandwidths;
- Antenna splitters and a high-gain antenna;
- Support of up to two ISDN PRI (DSS1) or one VoIP (SIP) connections;
- Sending / receiving SMS;
- A large memory for detailed Call Data Records (CDR);
- Detailed call statistics generating;
- Quick start - being free of an operating system (programmed in the processor code), the system is completely ready within 30 seconds after power on/restart. Of course, the full function time of all GSM modules depends on the current load and capacity of the GSM networks to which the gateway is connected;



- Intelligent call processing – Least Cost Routing (LCR), SMS and Voice CallBack, Auto CLIP routing, DISA dial-in;
- Intelligent selection of GSM / UMTS module to be used;
- Support of remote SIM card function (2N<sup>®</sup> SIM Star);
- Possibility to replace internal LCR with an external solution (2N<sup>®</sup> ERM);
- Remote control, configuration and firmware upgrade;
- High connection rate and ASR, low PDD.

## 1.3 Innovations

- The manufacturer is committed to improving the control program that is included in this product (referred to as firmware and bootware). The used ISP (In System Programming) technology gives you the possibility to store the latest control program in your StarGate / BlueStar / BlueTower gateway by means of a standard computer. For the most recent version of the configuration tool and additional software together with all necessary components refer to [www.2n.cz](http://www.2n.cz) and for necessary instructions see the System Upgrade section hereof. It is recommended that you use the most recent version of the program to avoid unnecessary problems and shortcomings that have already been eliminated.
- If you program your StarGate / BlueStar / BlueTower parameters by means of a computer, you need the PRI config program or a web browser (when using the eCPU web interface ). Find the latest version of this programming tool at [www.2n.cz](http://www.2n.cz) as well.
- At [www.2n.cz](http://www.2n.cz) you will also find the most recent version of this manual in the popular PDF format. We recommend you to use it especially in connection with the control program upgrade as it introduces new useful functions.
- Preliminary information on functions that are not yet available are typed on a light grey background or use grey letters instead of black ones.

# 1.4 Terms and Symbols Used

## Manual Symbols

---



### Safety

- **Always** abide by this information to prevent personal injury.



### Warning

- **Always** abide by this information to prevent damage to the device.



### Caution

- **Important information** for system functionality.



### Tip

- **Useful information** for quick and efficient functionality.



### Note

- Routines or advice for efficient use of the device.

## Future Functions

---

A grey-marked text in this document specifies the **2N® StarGate/BlueStar/BlueTower** functions that will be supported in the future.



# 2

## Description and Installation

This section describes the **2N® StarGate/BlueStar/BlueTower** product and its installation.

Here is what you can find in this section:

- Plug-In Boards
- Antenna and Antenna Splitters
- Gateway Rack Configuration
- Installation

# 2.1 Plug-In Boards

All plug-in cards have defined positions in the system rack. Please keep all cards in their respective positions. Wrong positions may cause malfunction of the whole system. The type and quantity of the cards used in your 2N® StarGate / BlueStar / BlueTower gateway depend on the part number of the gateway and other components.



**Note**  
■ All status LEDs (as described below) provide basic status information only. For detailed information use the terminal or configuration tool.

## Basic CPU Board

The basic CPU board carries only the main CPU, which supports all basic features of the gateway. The advanced features of the enhanced version (Web interface, 2N® SIM Star support, SMS2Outlook, Web configuration and **SNMP**) are not available.

### Board Description

The CPU board contains a processor system controlling the whole system. The board is designed on a 4-layer PCB of the size of 160x100mm. A simple COM1 serial interface, an Ethernet connector (10Base-T) and 5 board status LED indicators are located on the front panel.

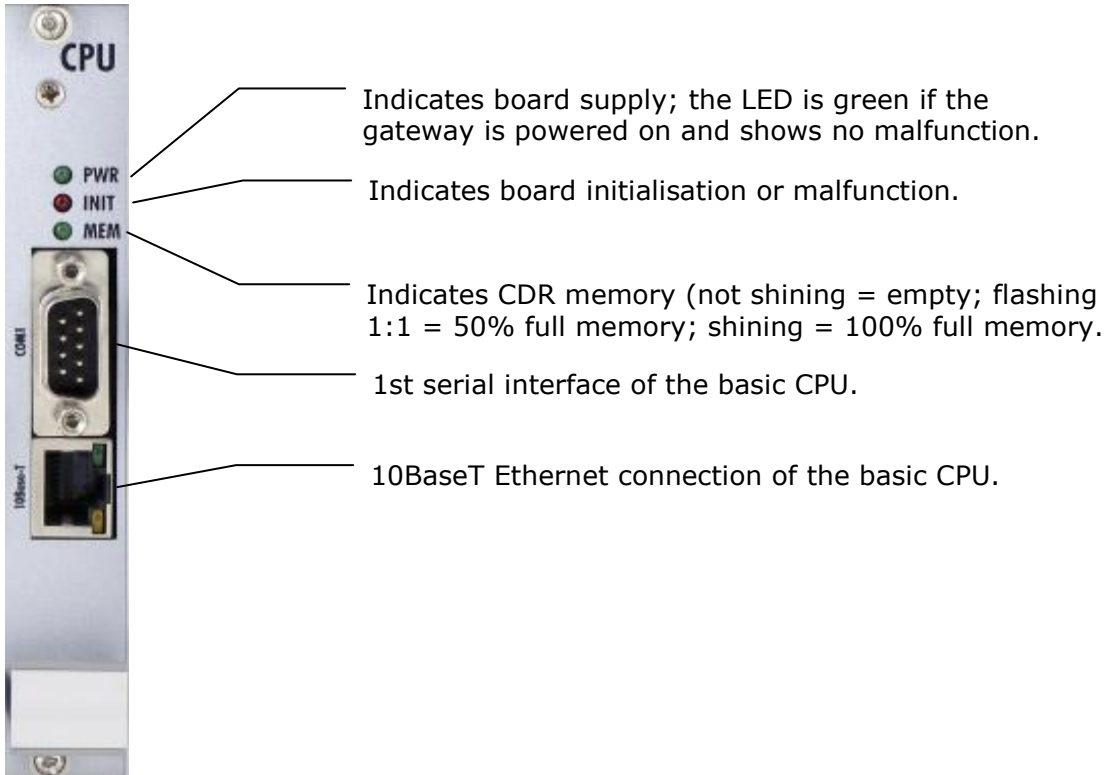

---

## COM1 Serial Interface Parameters

---

The COM1 interface is used as a local port for temporary connection of a PC (terminal) for installation and servicing purposes and permanent connection of the SMS server (supervision PC). It provides local monitoring, configuration, tracing and firmware upgrade.

Transmission rate	57.6 kbps
Bit format	start, 8bit, stop (no parity)
Signals	RXD, TXD, RTS, CTS, GND

---

## Lithium Battery Replacement

---



### Warning

- An incorrect battery replacement may cause explosion. The battery can only be replaced with a battery of the same or equivalent type as recommended by the manufacturer. Handle used batteries as instructed by the manufacturer.

The lithium battery on the CPU board backs up the internal real time clock in case of supply power outage. Its average life is about three years and should be replaced preventively after this time. Replacing the lithium battery, be sure to turn the subrack power supply unit off using the mains switch and, having loosened the two fitting screws, push the CPU board out. Remove the old battery from the holder using a suitable tool and insert a new one. Restore the original status taking the said steps in the opposite order. **Battery type: CR2430.**



### Warning

- Never use metal tools for battery replacement; neither the new nor the old battery may be short-circuited! A short-circuit may result in battery damage or explosion!!!

Dispose of used batteries in accordance with applicable regulations - put them in a recycling yard, for example.

---

## Configuration Jumpers

---

There are two configuration jumpers on the CPU board. Being inapplicable at present, JP1 is disconnected by default. JP2 is intended for switching the serial port between the CPU board and an optional extension board. By default, JP2 is connected.

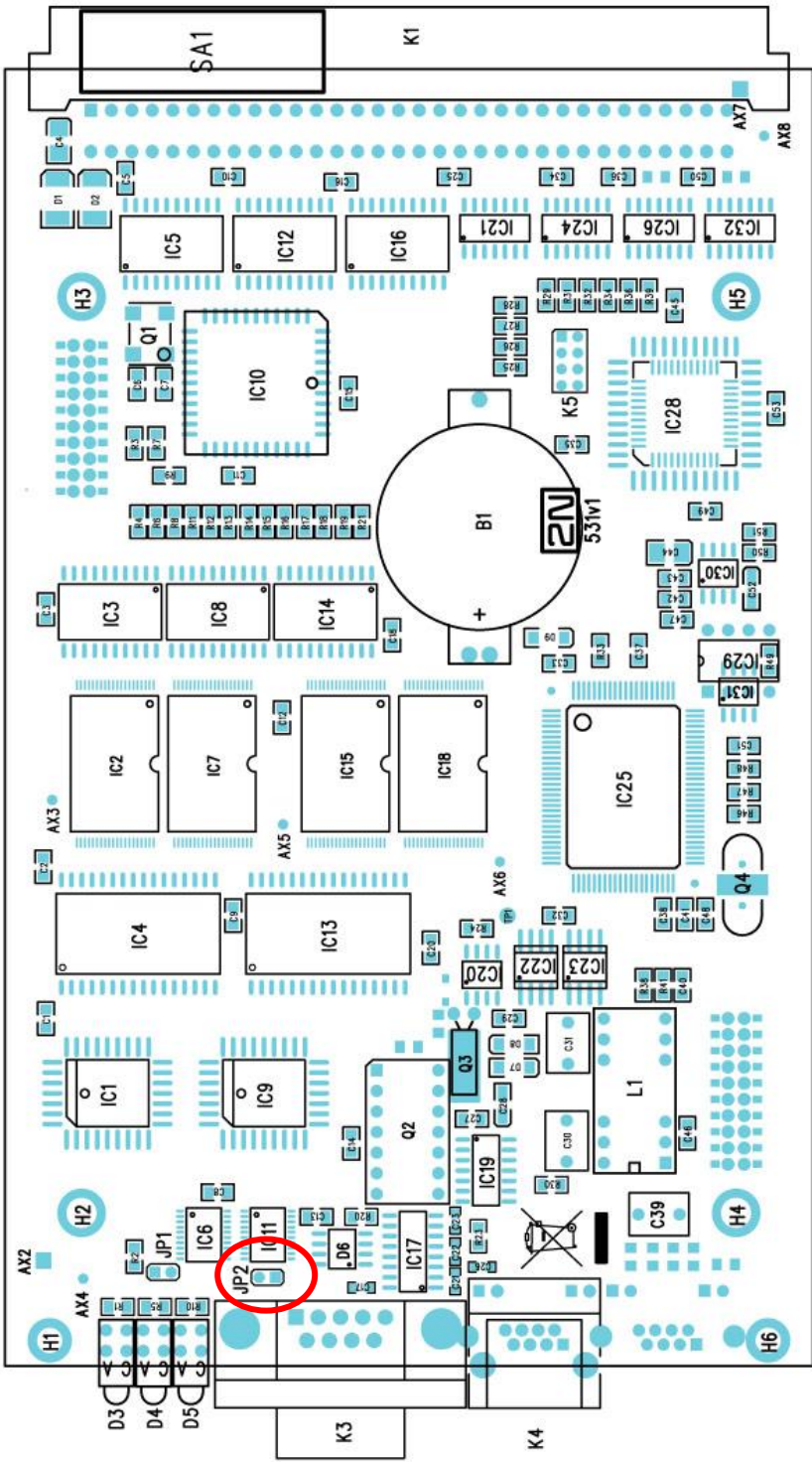

Fig. 2.1 Configuration Jumpers



# Enhanced CPU Board

The enhanced version of the CPU board carries two boards with a main CPU and an extension unit. The main CPU and extension unit have a dedicated Ethernet connector and share a serial interface (switchable by the jumper located on the main CPU board). The enhanced CPU board supports all features of the basic CPU and some additional features:

- A comfortable graphic web interface for easy gateway remote control and configuration;
- Support of the 2N<sup>®</sup> SIM Star system;
- Support of the SMTP and POP3 protocols for sending / receiving SMS;
- CDR downloader (an SD card is required);
- SMS and Call simulator;
- **SNMP remote control.**

Some features can be limited by the licence file. For detailed information please read Section 3 – Configuration.

## Board Description

The board is designed on a 4-layer PCB of the size of 160x100mm. There is also an extension card located on the main PCB. The board has one simple COM1 serial interface shared by both the CPUs, two Ethernet connectors (CPU=10Base-T and Ext. unit=100Base-T), and 10 board status LED indicators on the front panel.

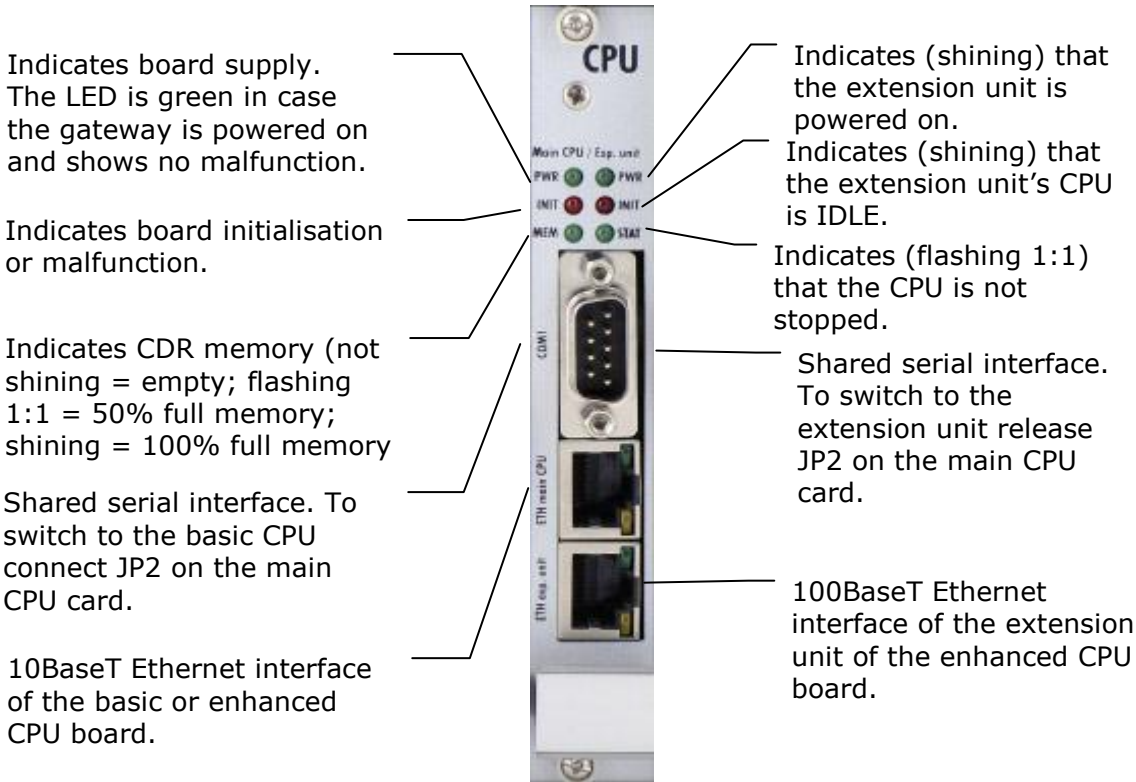

Main = Indication LEDs of the main (basic) CPU.

Ext. unit = Indication LEDs of the extension unit.

## COM1 Serial Interface Parameters

The COM1 interface is used as a local port for temporary connection of a PC (terminal) for installation and servicing purposes and permanent connection of the SMS server (supervision PC). It provides local monitoring, configuration, tracing and firmware upgrade.

In the case of switch JP2, switch the COM1 interface to Ext. unit where you find the console menu for basic Ext. unit IP settings. To locate JP2 please check the figure below in the Configuration Jumpers section.

### Basic CPU connection:

Transmission rate	57.6 kbps
Bit format	start, 8bit, stop (no parity)
Signals	RXD, TXD, GND

### Ext. unit connection:

Transmission rate	115.2 kbps
Bit format	start, 8bit, stop (no parity)
Signals	RXD, TXD, GND



### Tip

- To communicate with the basic and enhanced CPUs at the same time via a serial interface, use COM1 for communication with the enhanced CPU and COM2 (located on AUX card) for communication with the basic CPU.

## Lithium Battery Replacement



### Warning

- An incorrect battery replacement may cause explosion. The battery can only be replaced with a battery of the same or equivalent type as recommended by the manufacturer. Handle used batteries as instructed by the manufacturer.

The lithium battery on the CPU board backs up the internal real time clock in case of supply power outage. Its average life is about three years and should be replaced preventively after that time. Replacing the lithium battery, be sure to turn the subrack power supply unit off using the mains switch and, having loosened the two fitting screws, push the CPU board out. Remove the old battery from the holder using a suitable tool and insert a new one. Restore the original status taking the said steps in the opposite order. **Battery type: CR2430.**



### Warning

- Never use metal tools for battery replacement; neither the new nor the old battery may be short-circuited! A short-circuit may result in battery damage or explosion!!!

Dispose of used batteries in accordance with applicable regulations - put them in a recycling yard, for example.

## Configuration Jumpers

There are two configuration jumpers on the enhanced CPU board. JP2 is intended for switching the serial port between the CPU board and an optional extension board. By default, jumper JP2 is connected = the serial port is switched to the basic CPU. JP3 is designed for restoring default settings of the enhanced CPU. JP3 is located on the upper PCB. To restore the default values follow the steps below:

- Switch off the GSM gateway;
- Remove the CPU card and connect JP3;
- Insert the CPU card and switch on the GSM gateway;
- Wait for one minute and switch off the GSM gateway again;
- Remove the CPU card and release JP3;
- Insert the CPU card and switch on the GSM gateway.

Now the factory settings are restored on the enhanced CPU.



### Tip

- To restore the factory settings you can also get connected to the serial console and select the Factory reset option.

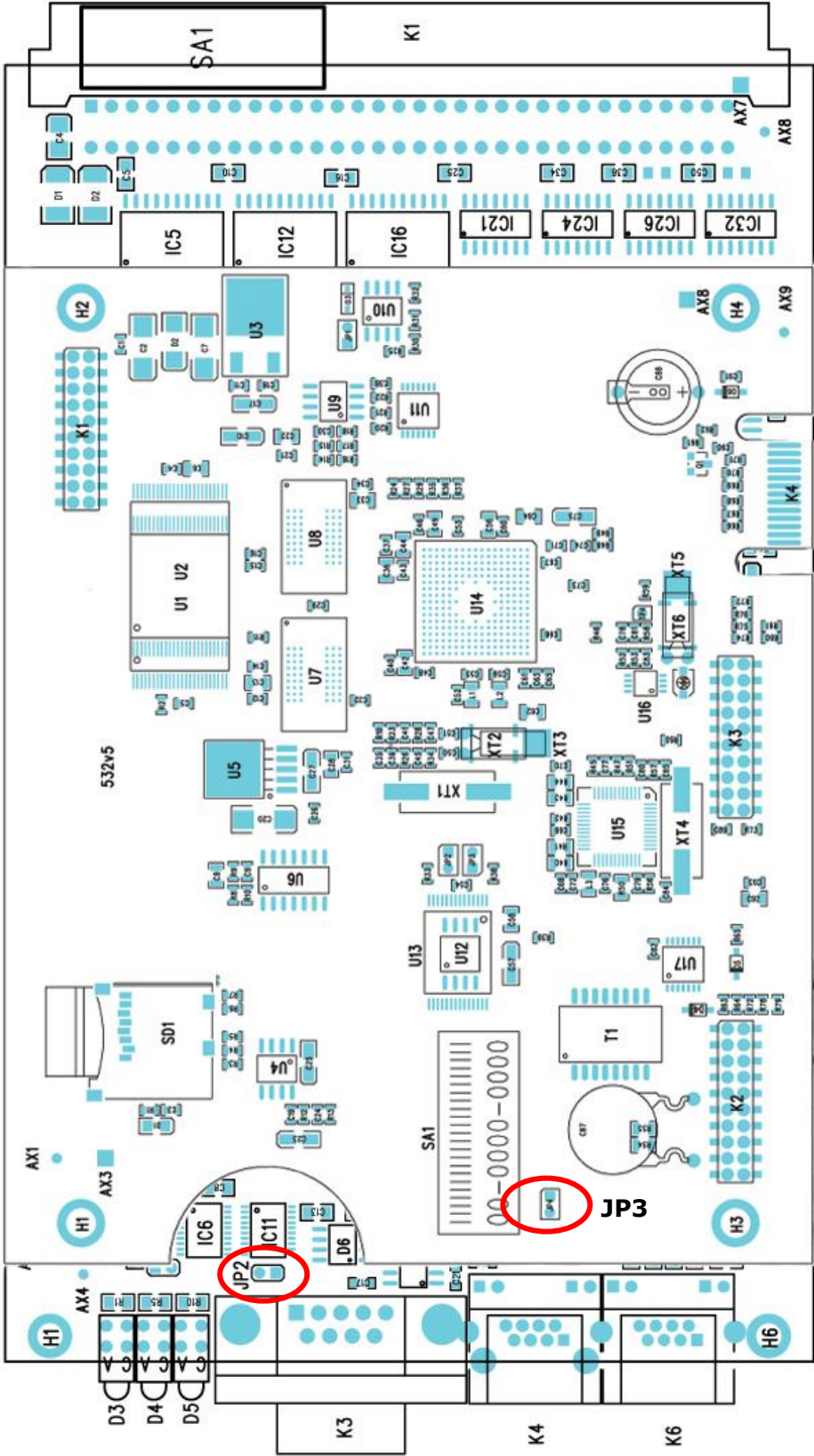
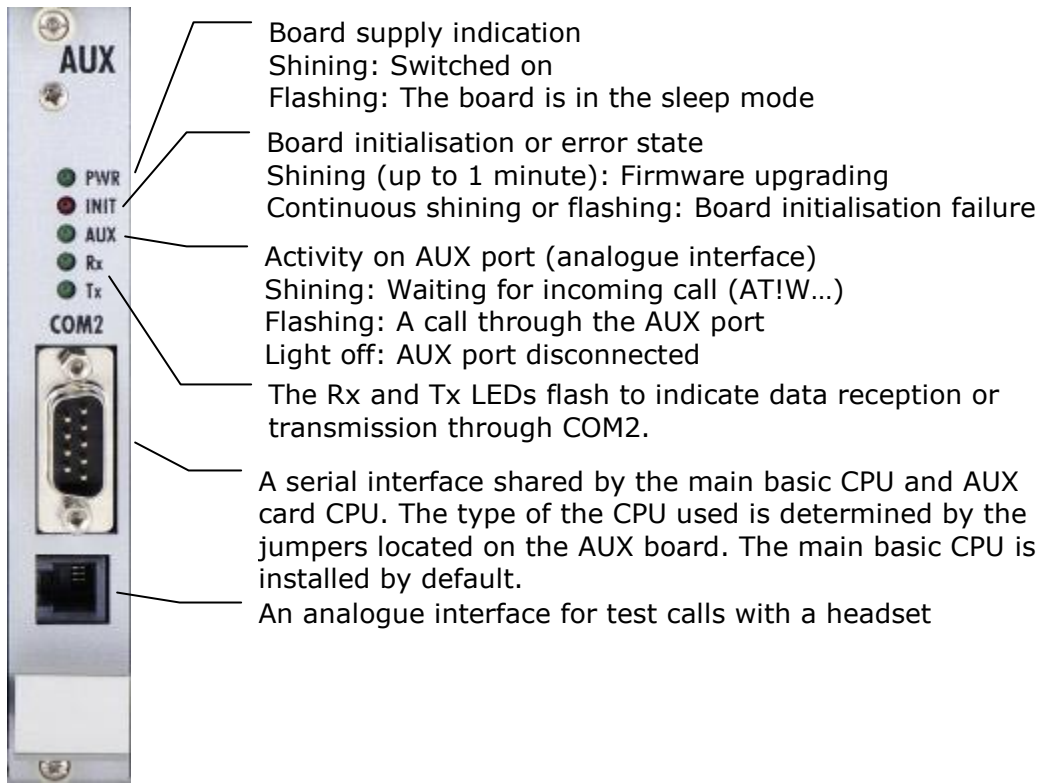

Fig. 2.2 Configuration Jumpers

# AUX Board

## Board Description

The AUX board contains a switching array and storage of voice messages controlled by an independent processor system separated from the system bus. The AUX port is used for making test calls or recording voice messages. The input amplifier is designed for an electret microphone, the output amplifier for 150 Ohm earphones. The board is designed on a 4-layer PCB of the size of 160x100mm. A serial interface COM2, handset or headphone connector, and 5 board status indicators lead to the front panel.



## COM2 Serial Port Parameters

The COM2 interface is used as a supervision port for remote connection of a PC (terminal) using the ISDN or analogue modem (also for loading voice messages into the AUX board processor memory). It provides remote monitoring, configuration, tracing and firmware upgrade.

Transmission rate	57.6 kips
Bit format	start, 8bit, stop (no parity)
Signals	complete 9-pin wiring

### Configuration Jumpers

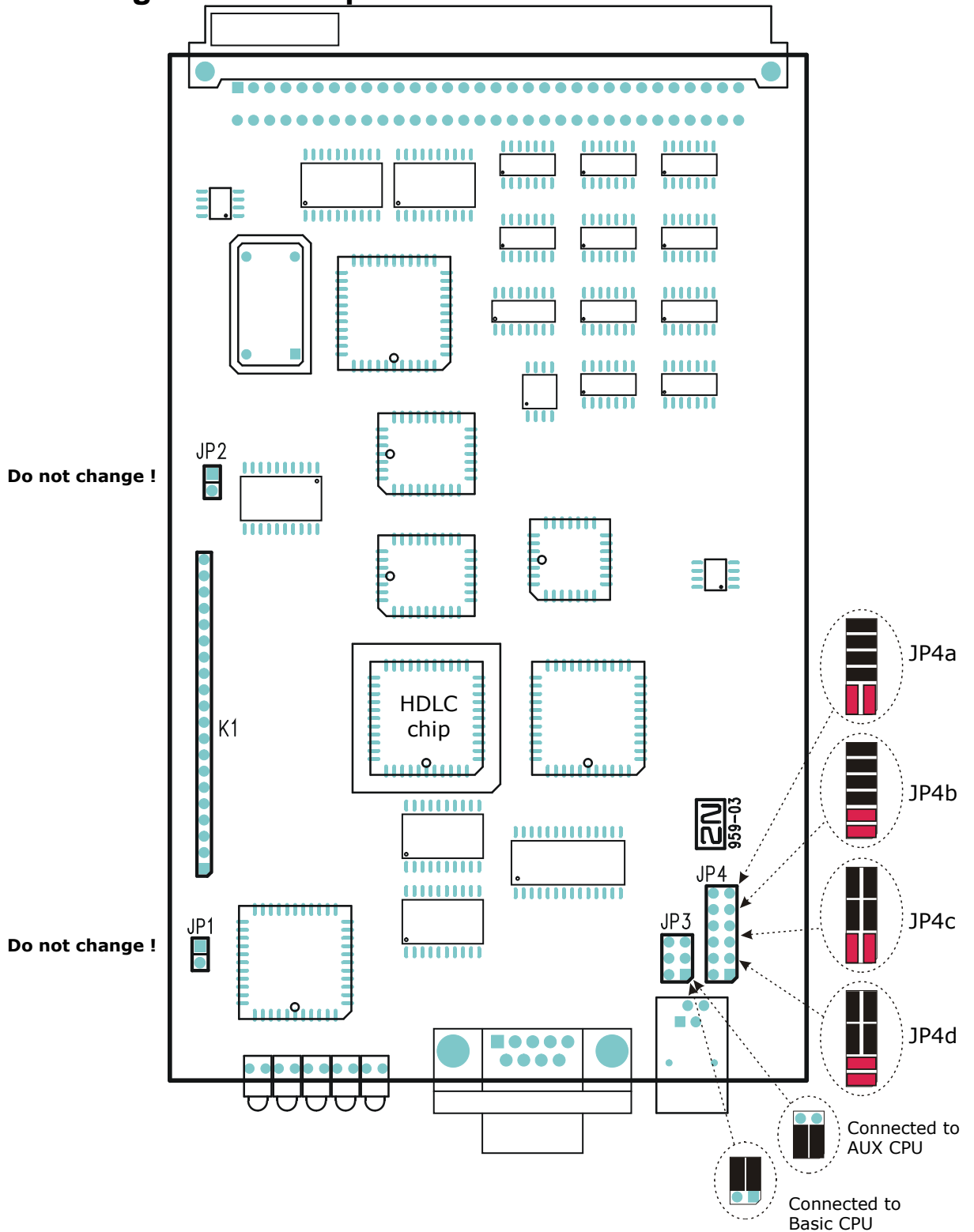

There are four configuration jumper blocks on the AUX board. Jumpers JP1 and JP2 are disconnected by default – please do not change their statuses. The JP3 jumper field helps you redirect the COM2 interface for DISA voice message uploading. The JP4 jumper block is used for setting the AUX interface to correspond with the handset or headphone configuration. By default, jumpers JP1 and JP2 are disconnected, jumpers

JP3 are connected as shown in Fig. JP3a (connected to the main basic CPU) and jumpers JP4 are configured as shown in Fig. JP4a.

---

## ISDN PRI Interface Remote Control Chip

---

An HDLC chip is also located on the AUX board, enabling remote control over the ISDN PRI interfaces. This chipset is an optional part of system.

The following step-by-step guide will show you how to plug it into the AUX card.



Position of the chip cap on the AUX board.



Insertion of the chip to the cap.  
**ATTENTION!** Please watch the chip orientation – it must be the identical with that of the other chips!



Carefully press the chip into the cap.



View of a successfully installed chip on the AUX board.



# PRI Board

## Board Description

The PRI board contains one or two (depends on the part number) ISDN interfaces and PCM bus timing circuits. PRI 1 is designed as an internal interface (with an activated LCR function) and PRI 2 as an external interface (all calls from the port are always routed to PRI 1). The interface can work in the MASTER or SLAVE mode (set the PRI 1 mode using the configuration tool and PRI 2 has always the opposite mode). The output can be configured as TERMINAL (TE) or NETWORK (NT) by jumpers (switching of wires – for software switch you have to use the configuration tool!). The settings of these jumpers HAVE TO match the PRI configuration – two NT and TE modes will cause malfunction of the PRI board or back-up connection\* ! The board is designed on a 4-layer PCB of the size of 160x100mm. There are also 5 (or 8 in 2ISDN PRI) board status indicators, which are located on the front panel.

\* The PRI board contains four switches (can be deactivated by jumpers), which provide hardware connection between PRI 1 and PRI 2 in case the system is switched off or inoperative.

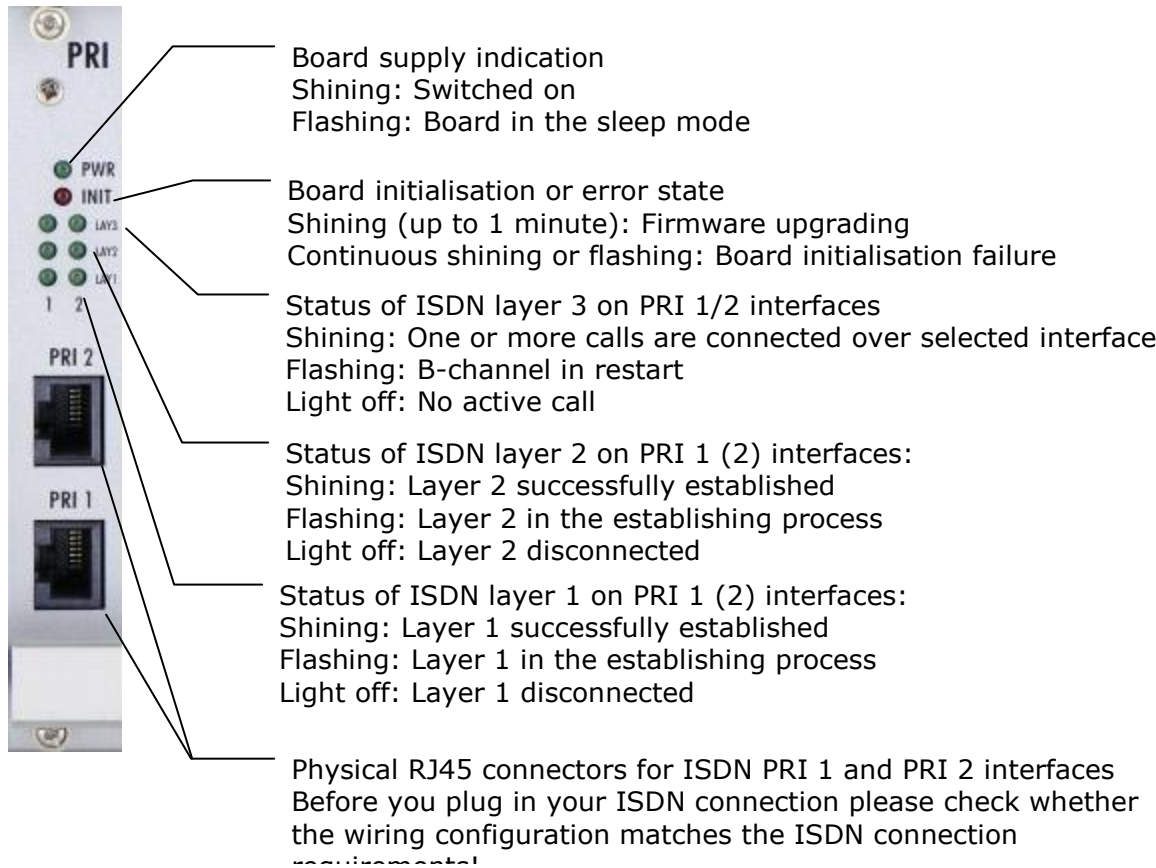

### Tip

- The LED statuses provide basic information on the ISDN interface only. For details on the ISDN interface state refer to the configuration tool.



## Configuration Jumpers

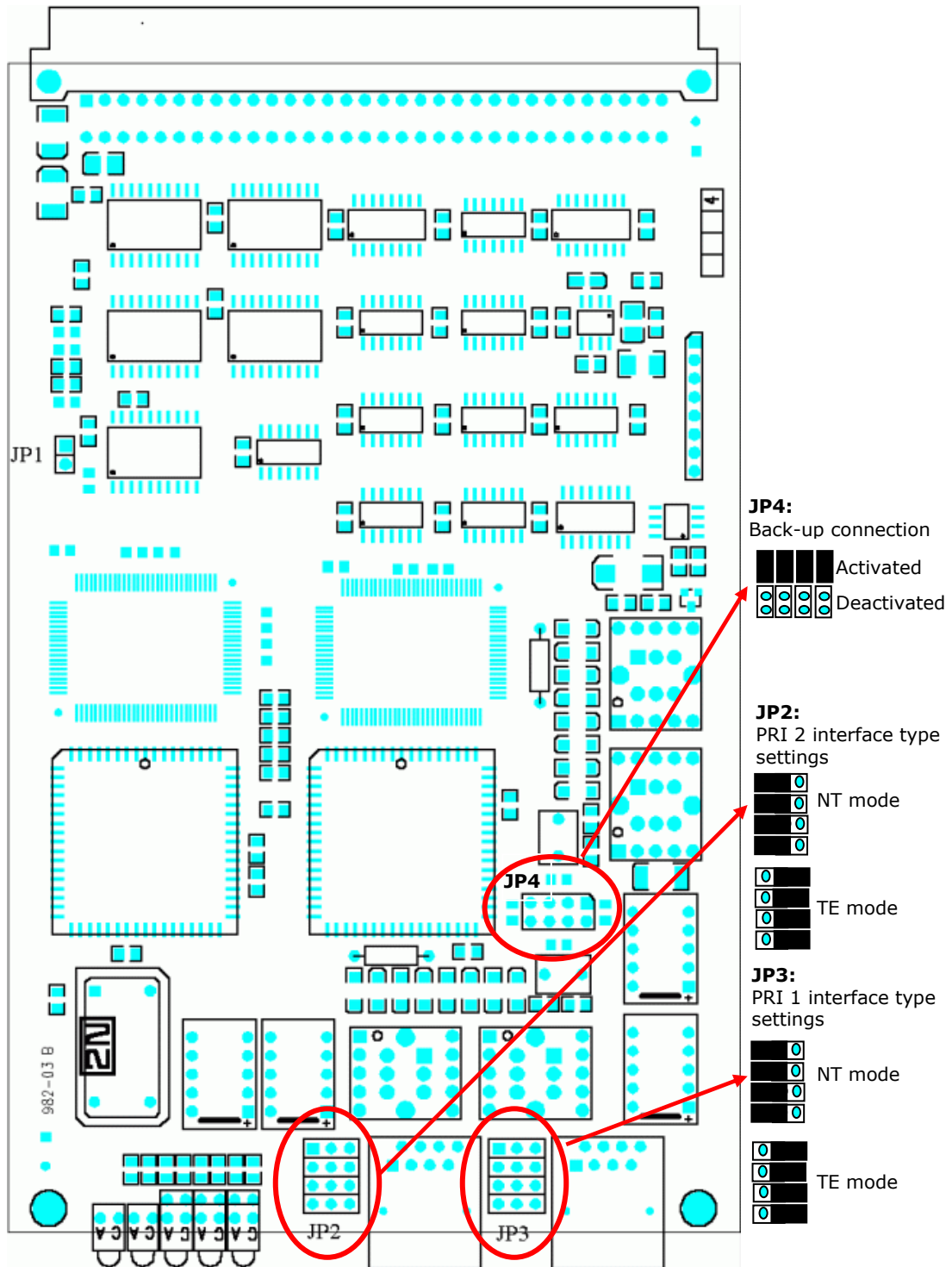

There are three configuration jumper blocks on the PRI board. JP2 and JP3 are used for hardware switching of the ISDN PRI connector into the TE / NT configuration. This operation means only swapping of the transmitting and receiving connector pairs, the interface configuration must be made using the configuration tool. With jumper JP4 you can activate/deactivate the back-up connection between PRI 1 and PRI 2 in case the system is switched off or the PRI board is not handled by system .



**Warning**

- The back-up connection (JP4) works only in case the wire settings of PRI 1 (JP3) and PRI 2 (JP2) are set in the opposite way (e.g. PRI 1 as NT, PRI 2 as TE).



**Note**

- Boards with just one PRI interface (1PRI boards) have the same settings as the PRI 1 interface on 2PRI boards. And there is no back-up connection (JP4) either.

**Positions of Tx and Rx Wires**

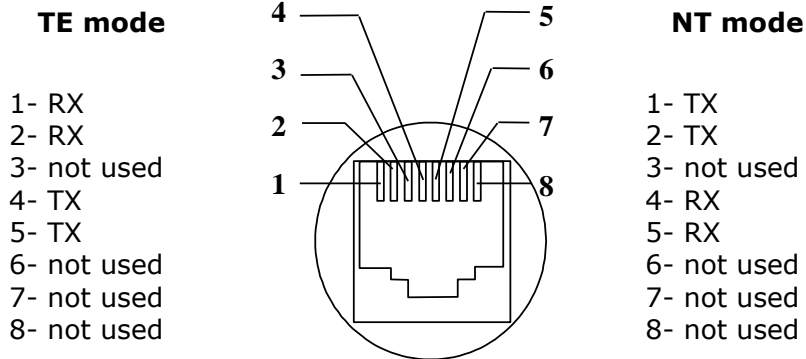

**Example of Connection with 1ISDN PRI Board**

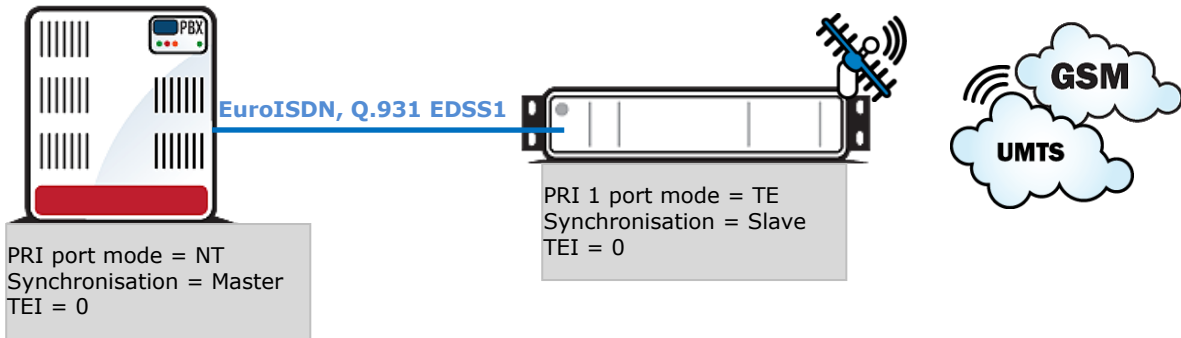

Example of Connection with 2ISDN PRI Board

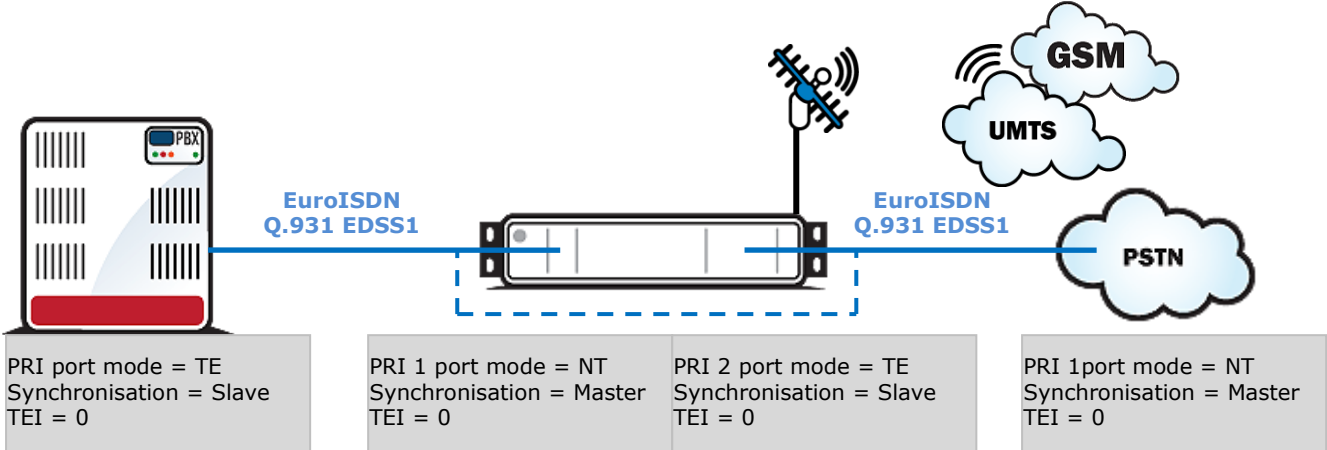

- ISDN PRI connection between two PRI interfaces
- - - Back-up-connection of the 2PRI board



**Warning**

- The ISDN port mode (TE or NT) and synchronisation type (Master/Slave) must be different on the PBX (PSTN) and on the gateway. The TEI number must have the same value (default = 0).

## VoIP Board

### Board Description

The VoIP board contains a digital signalling processor (DSP), 4x10/100BaseT Ethernet switch and a small carrier board with the licence chip. The main board is designed on a 6-layer PCB of the size of 160x100mm. Two board status LED indicators are located on the front panel. Configuration (e.g. used voice codecs, IP setting) is completely managed by the main CPU and made via a standard configuration tool. There is no fixed memory (EEPROM) for the VoIP card firmware. The firmware is saved on the basic CPU and uploaded to the VoIP card upon every VoIP card start / restart.

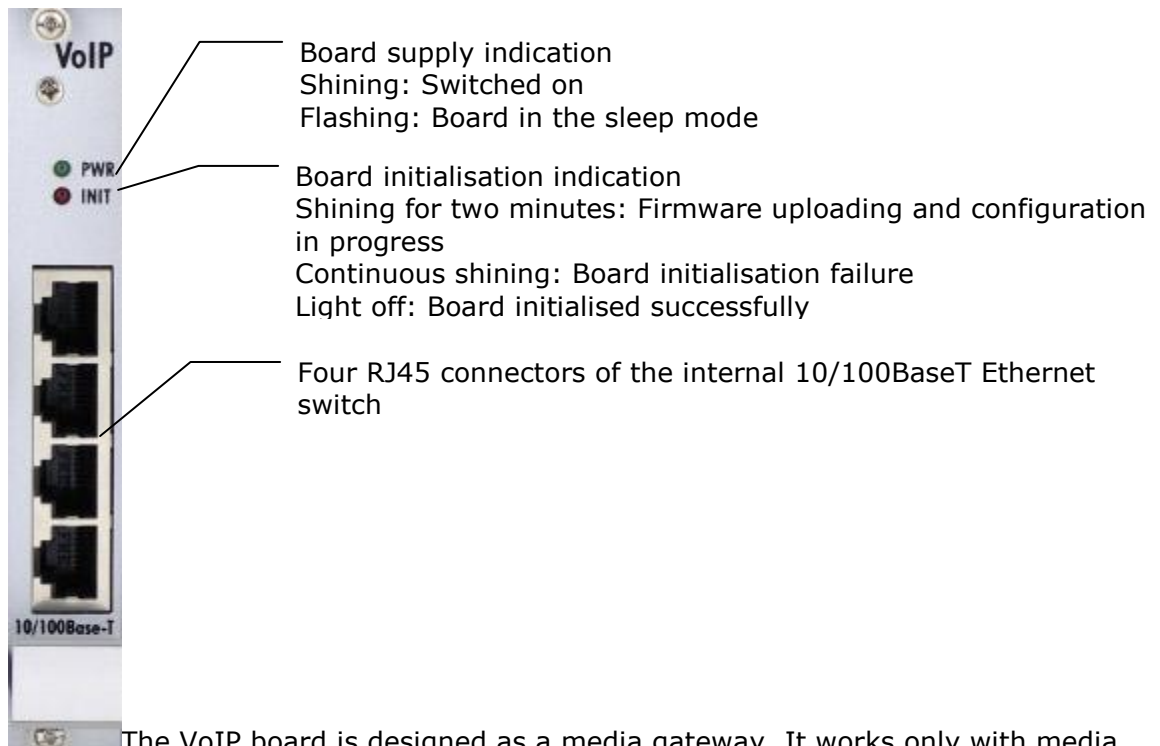

The VoIP board is designed as a media gateway. It works only with media packets (RTP); signalling packets (SIP) must be routed to the basic CPU IP address.



#### Tip

- You have to restart the VoIP card upon any VoIP configuration change.



#### Caution

- For a successful VoIP card initialisation, the VoIP board MAC address has to be filled in correctly and the basic CPU must be switched to the VoIP-SIP mode and contain the VoIP firmware file.
- The integrated Ethernet will not work until the VoIP card has been initialised successfully.

### Configuration Jumpers

There are no configuration jumpers on the VoIP card.

#### Example of Correct VoIP Interface Connection

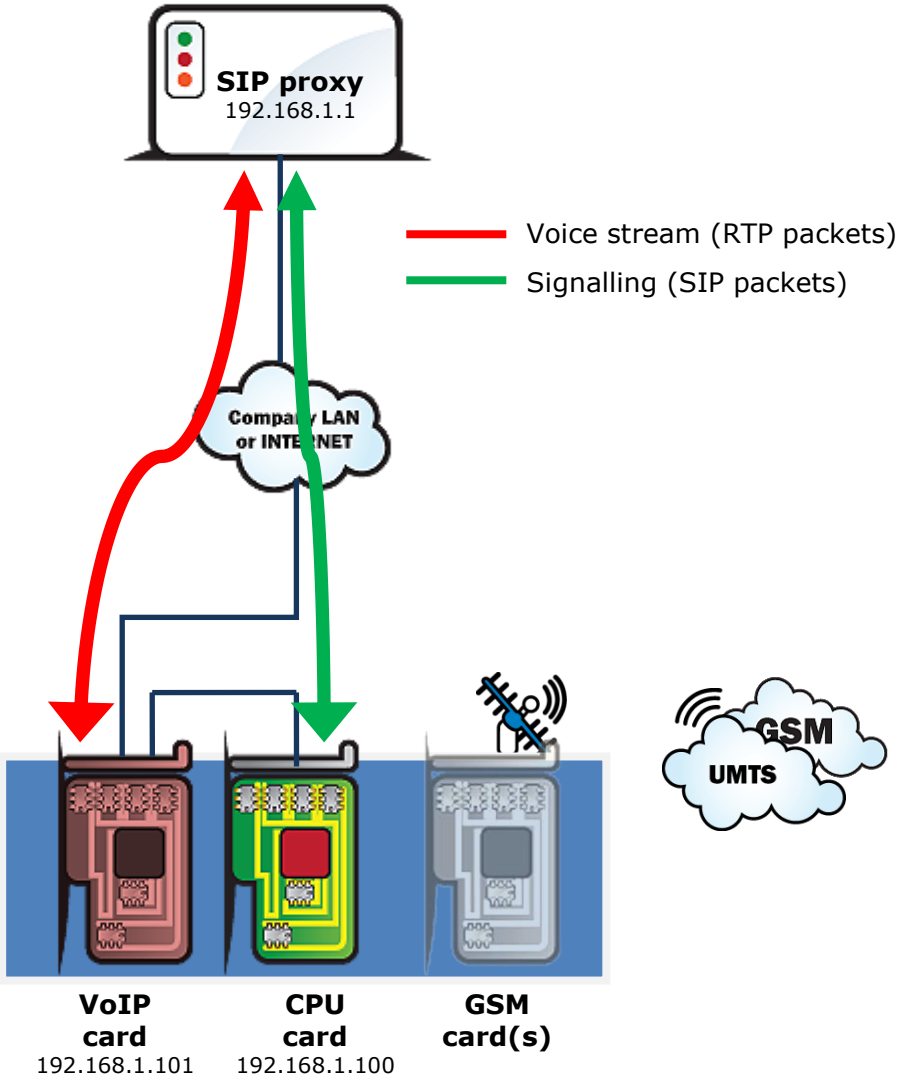

2N® StarGate / BlueStar / BlueTower

## GSM / UMTS Board

### Board Description

The GSM / UMTS board contains two GSM or UMTS wireless modules, circuits for their connection to the PCM bus, and DTMF receivers (+CPU in the case of board with the 2N<sup>®</sup> SIM Star support). The board is designed on a 4-layer PCB of the size of 160x100mm. Pins 1 and 32 are approximately 1 mm longer in the GSM board system connector and are used for 'hot swap' power feeding, allowing to push the board in and out even during operation. This feature is especially handy while installing or replacing SIM cards. Two SMA antenna connectors and 5 board status indicators are located on the front panel.

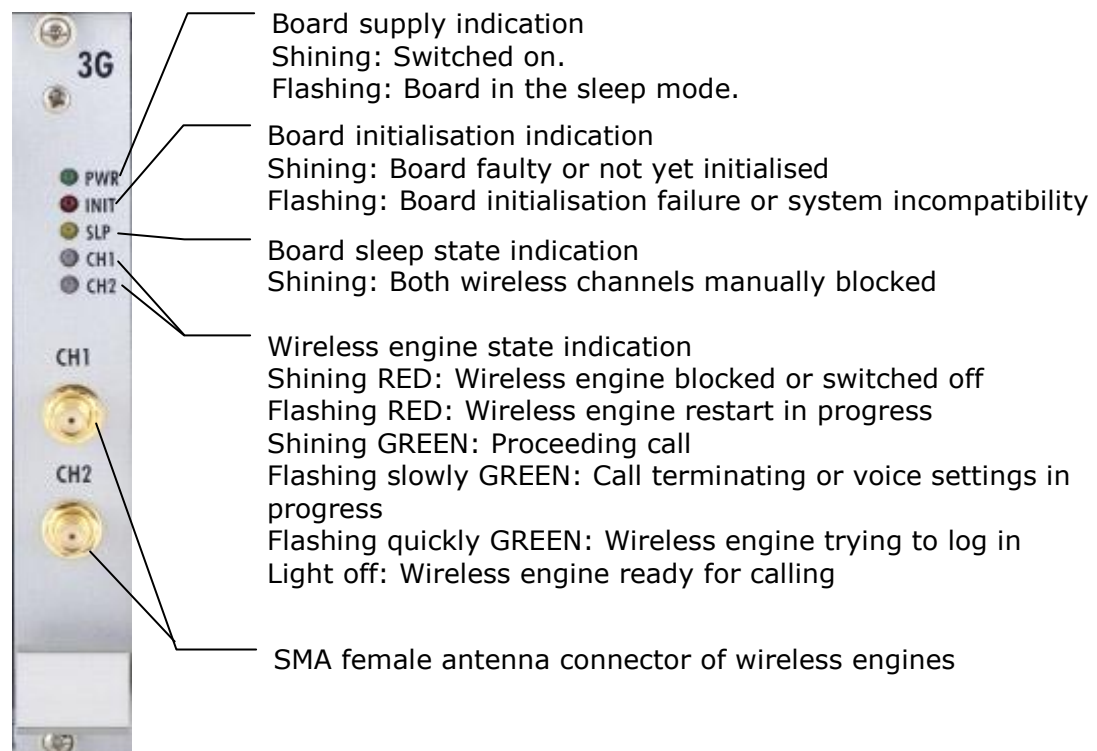

### Tip

For an easy SIM card replacement, all GSM / UMTS boards are designed as hot-swappable units.

### Board Types

The 2N<sup>®</sup> StarGate / BlueStar / BlueTower gateway can use several types of GSM or UMTS boards. The board specification includes the type of wireless device(s), count of SIM cards channel and 2N<sup>®</sup> SIM Star support data.

Table of available GSM / UMTS cards (2009):

- GSM board with 2 Cinterion MC55i engines, 4SIM/channel, no 2N<sup>®</sup> SIM Star support;

- GSM board with 2 Cinterion MC55i engines, 8SIM/channel, no 2N<sup>®</sup> SIM Star support;
- GSM board with 2 Cinterion MC55i engines, 1SIM/channel, 2N<sup>®</sup> SIM Star support;
- GSM board with 2 Wavecom Q55 (WMP100) engines, 4SIM/channel, no 2N<sup>®</sup> SIM Star support;
- GSM board with 2 Wavecom Q55 (WMP100) engines, 8SIM/channel, no 2N<sup>®</sup> SIM Star support;
- GSM board with 2 Wavecom Q55 (WMP100) engines, 1SIM/channel, 2N<sup>®</sup> SIM Star support;
- GSM board with 2 Wavecom Q55 (WMP100) engines, 4SIM/channel, 2N<sup>®</sup> SIM Star support;
- UMTS board with 2 SierraWireless MC8790V engines, 4SIM/channel, no 2N<sup>®</sup> SIM Star support;
- UMTS board with 2 SierraWireless MC8790V engines, 1SIM/channel, 2N<sup>®</sup> SIM Star support.

**Note**

- The GSM / UMTS boards can be locked for use in defined GSM / UMTS networks only. For additional information please ask your system supplier.

**SIM Card Positions on 4SIM/Channel Boards**

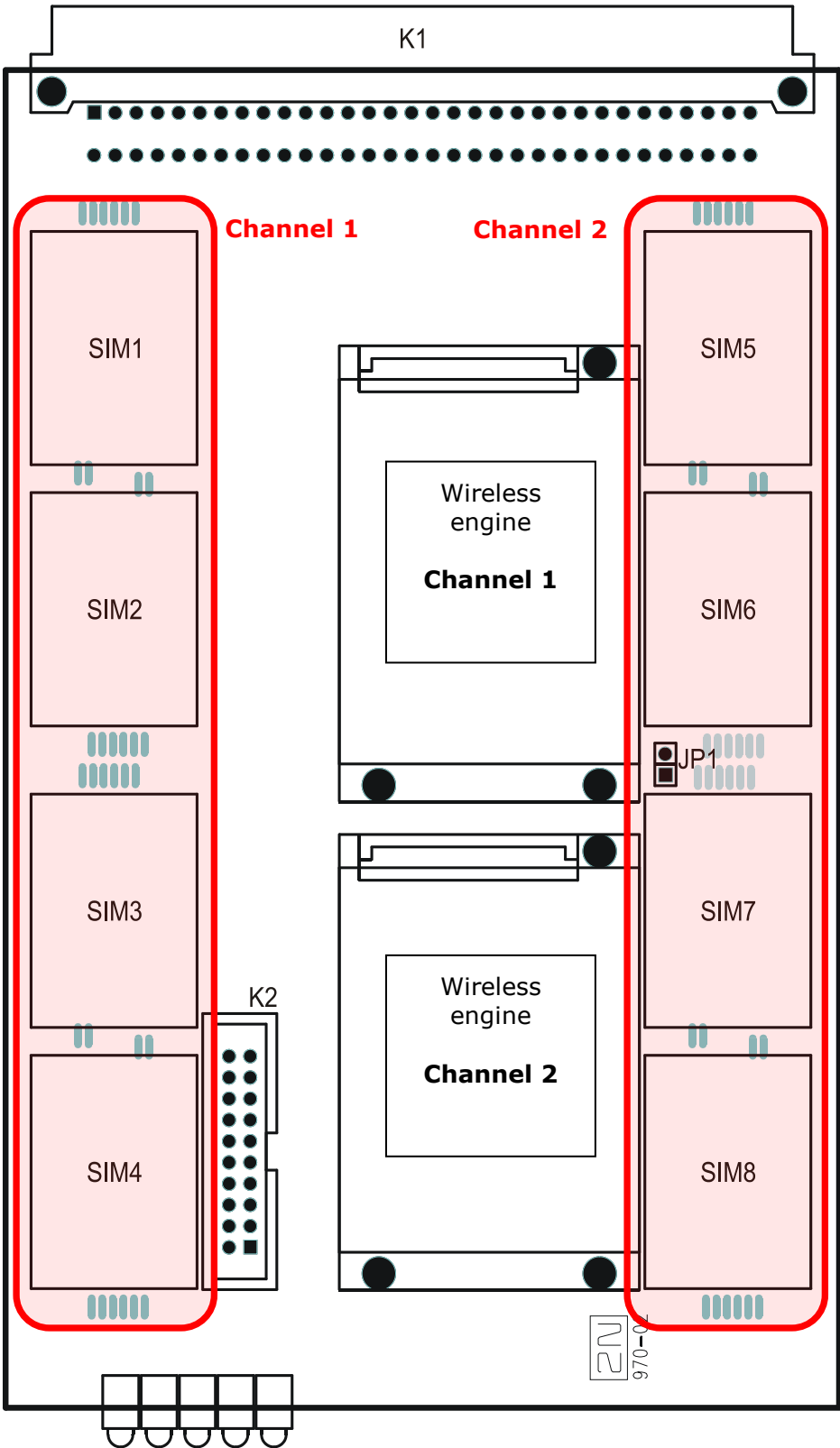



### SIM Card Positions on 8SIM/Channel Boards

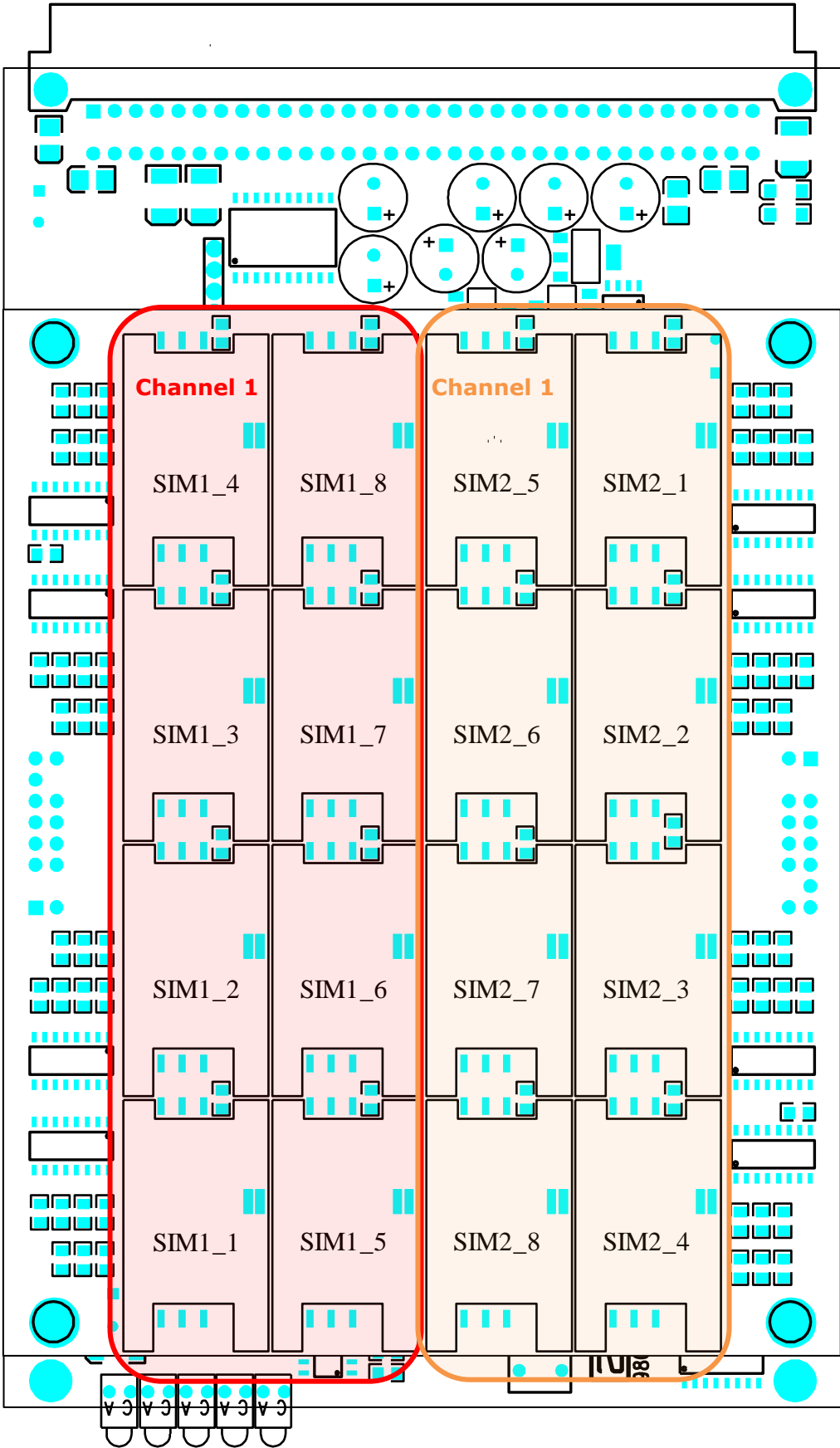

### SIM Card Positions on 1SIM/Channel Boards

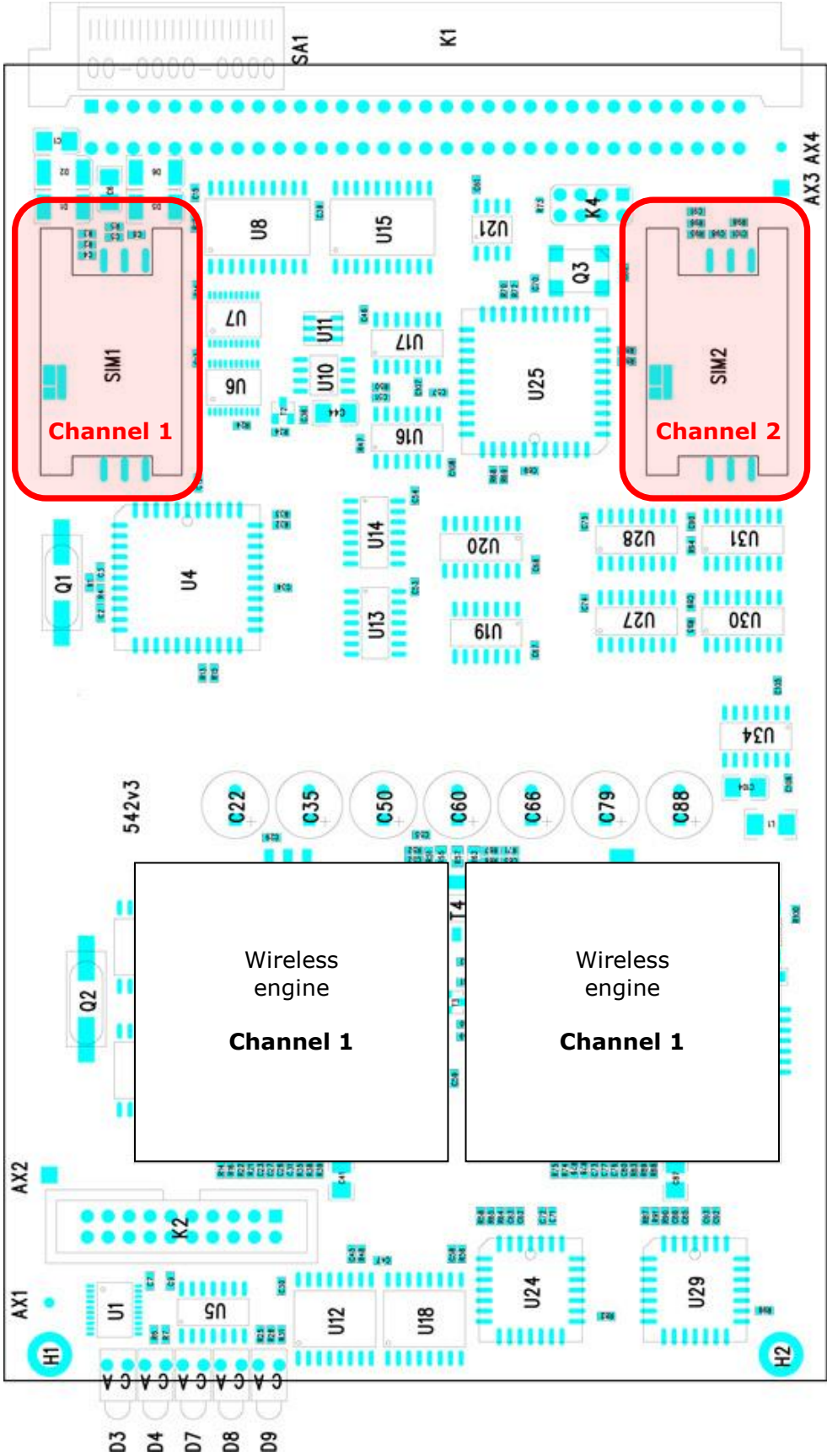

SIM Card Positions on 4SIM/Channel Boards

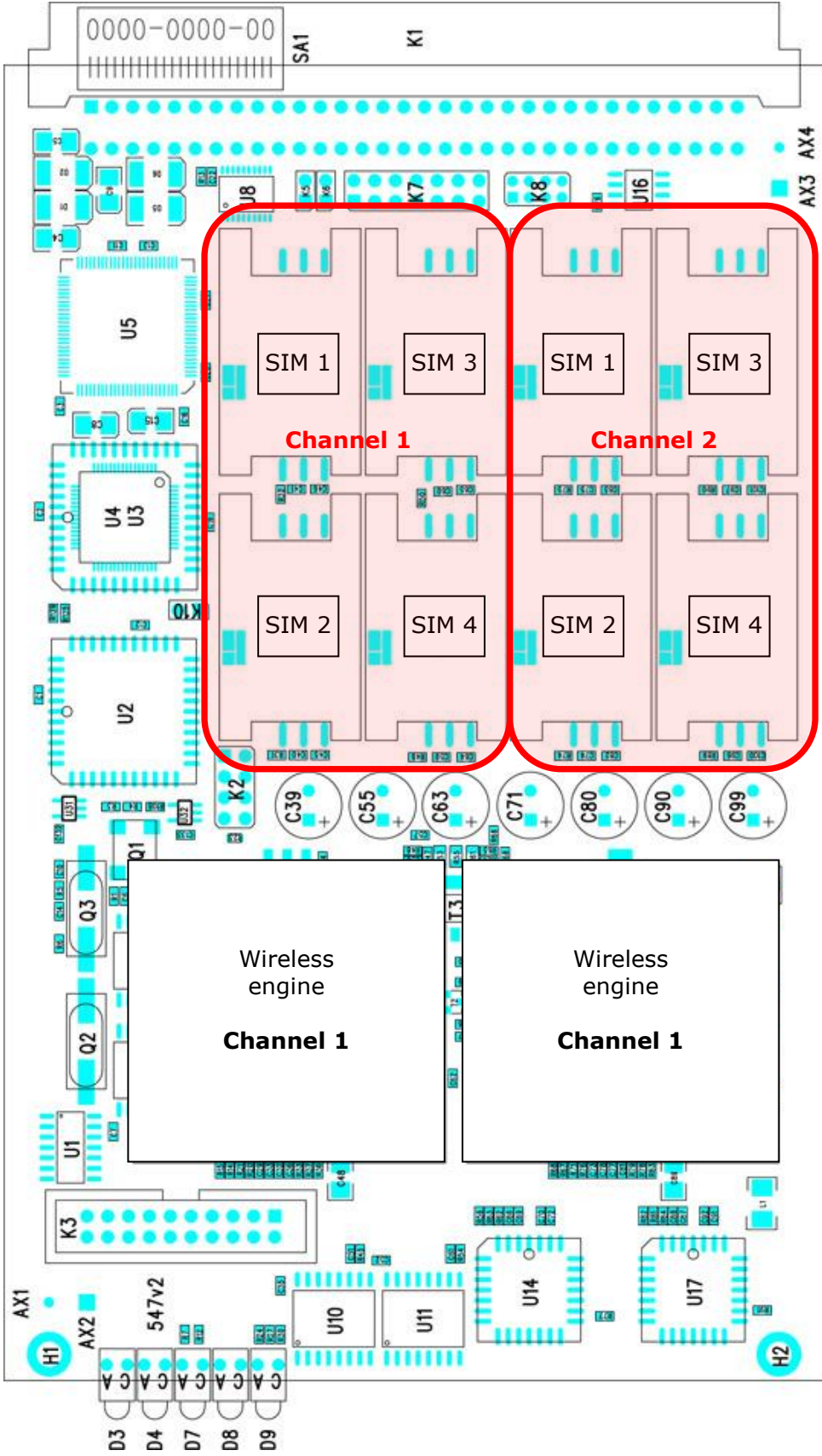

## 2.2 Antenna and Antenna Splitters

2N<sup>®</sup> offers several antenna splitter and antenna models providing the best signal quality on all GSM / UMTS engines. All the systems are designed for all UMTS and GSM networks.

### Antenna Splitter

The antenna splitter is designed for decreasing the number of antennas, antenna cables, outdoor antennas and roof mounting space. The antenna splitter is a passive unit suitable for GSM / UMTS gateways. The antenna splitter can be external (2N<sup>®</sup> StarGate) or internal (2N<sup>®</sup> BlueStar and 2N<sup>®</sup> BlueTower). Each splitter consists of one or more passive units, each of which has four / two inputs and one output.

Table of standard external antenna splitter configurations:

Number of inputs	Number of outputs	Input-Output insertion loss	Unit high
32	2	<15 dB	2U
32	4	<11 dB	2U
32	8	<8 dB	2U
16	1	<15 dB	1U
16	2	<11 dB	1U
16	4	<8 dB	1U
12	3	<8dB	1U

Table of internal antenna splitters for 2N<sup>®</sup> BlueTower:

Number of inputs	Number of outputs	Input-Output insertion loss	Unit high
4	1	<	3U

Table of internal antenna splitters for 2N<sup>®</sup> BlueStar:

Number of inputs	Number of outputs	Input-Output insertion loss	Unit high
16	2	<11 dB	3U
16	1	<15 dB	3U
8	2	<	3U
8	1	<	1U

Technical parameters of antenna splitters:

Parameters	Value	Note
<b>Connector type</b>		
Input connector	SMA type, female	
Output antenna connector	N type, female	
<b>RF parameters</b>		
Impedance	50 OHM	
Frequency	850 – 2100 MHz	
Insertion loss	< 8, 11, 15 dB	According to configuration
Isolation between two channels	> 20 dB	
<b>Output overvoltage protection</b>		
<b>Device type</b>		
	<b>Gas surge arrester</b>	
Protected voltage level	90 V	
Peak current	10 KA	
Insertion loss	0.2 dB	

### Splitter Examples



Internal Antenna Splitter for 2N® BlueStar



Internal Antenna Splitter for 2N® BlueTower

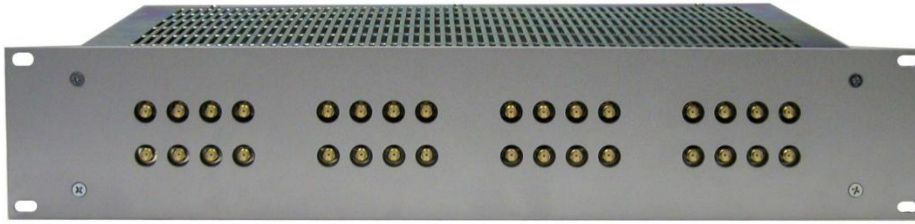

External Antenna Splitter for 2N® StarGate

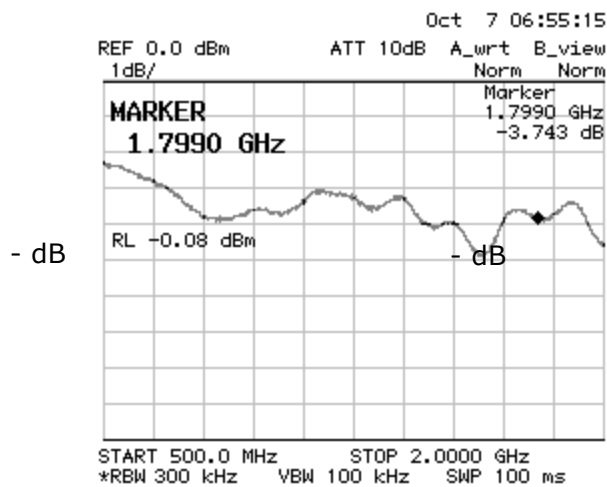

Insertion Loss Measurement

## Directional Antenna

The high-gain directional YAGI antenna is suitable for outdoor and indoor use. Basic parameters of the directional antenna:

Type	CPY 9214
Number of elements	14
Frequency	824 – 896, 1770 – 2100 MHz
Gain	9.5 dB / 13 dB
Cable	RG 58, 10m
V.S.W.R	< 1.5 : 1
Connector	N type, male



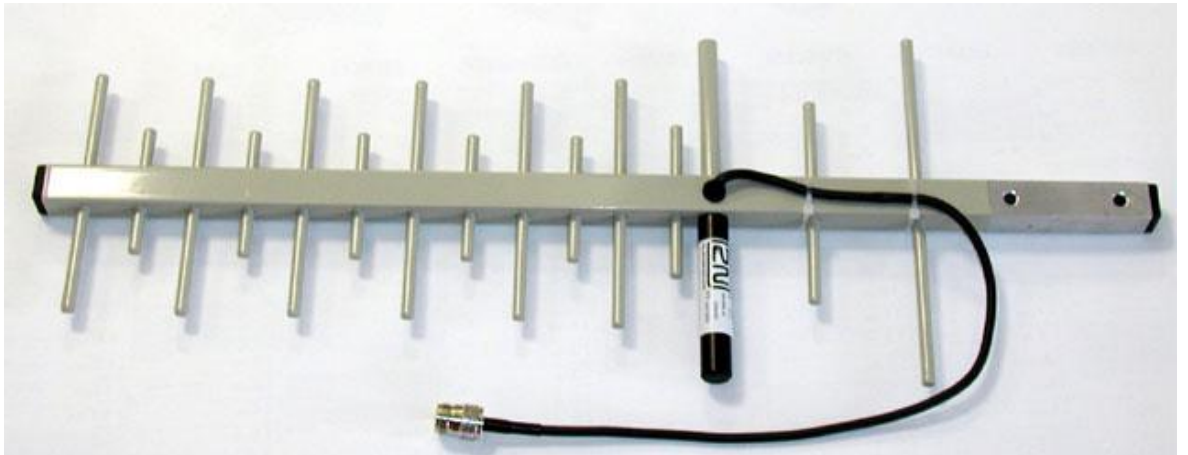

Directional Antenna



An Example of Correct Installation of Directional Antennas

**Warning**

- The antenna has to be placed in accordance with the applicable overvoltage protection and grounding safety rules.

## Discreet Antenna

---

The small omni-directional antenna is designed for indoor use and provides a good GSM / UMTS signal quality.

**Basic parameters of the discreet antenna:**

Type	Car antenna
Gain	2.5dB
Cable	Coax cable 174A (5 m)
Connector	SMA (male)

---



Discreet Antenna

## Directional Antenna Connection Cable

---

2N® offers you a special low attenuation cable in variable lengths. The cable terminating connectors are of the N type.



---

Type	H1000 PE coax cable
Impedance	50Ω
Operating frequency	5 – 2150 MHz
Used connectors	N type (female)
Cable size	10.3mm
Operating temperature	-40°C to +80°C
Total weight	120g / m
Minimum installation temperature	-5°C
Minimum static bend radius	75mm
Attenuation at 860MHz	14.1dB / 100m
Attenuation at 1000MHz	15.3dB / 100m
Attenuation at 1750MHz	21.3dB / 100m
Attenuation at 2050MHz	23.4dB / 100m

---

## 2.3 Gateway Rack Configuration

The 2N® StarGate / BlueStar / BlueTower gateways use different hardware rack types. For detailed information on the differences refer to Subsection 1.1 . All the systems can be distributed with a VoIP or ISDN interface. The main back bus located in the gateway hardware rack is pre-configured to a defined type of interface (VoIP or PRI). To change PRI into VoIP or vice versa, remember to reconfigure the back bus settings as follows:

There are six jumpers on the main bus between the 3<sup>rd</sup> and 4<sup>th</sup> connector (from the right). The jumper positions define the gateway type (VoIP or PRI).

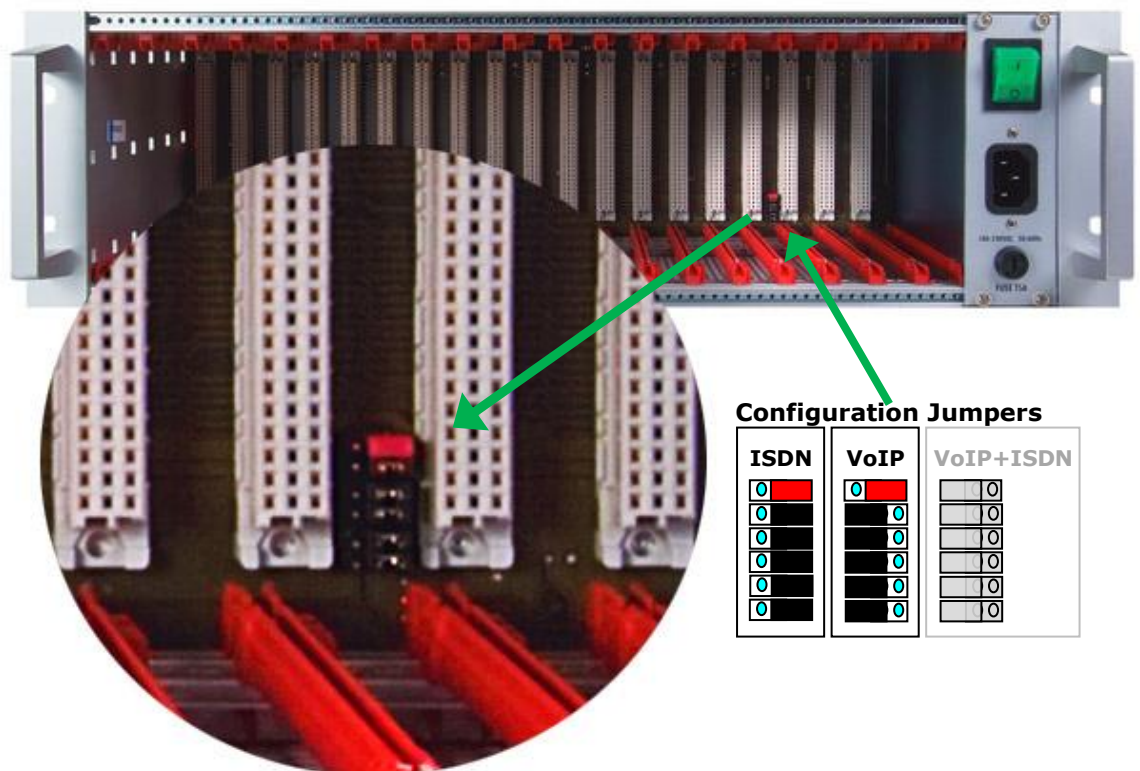

There are three setting options:

1) ISDN: The gateway is configured to work with the ISDN PRI card only as shown in the figure below:



2) VoIP: The gateway is configured to work with the VoIP card only as shown in the figure below:



3) VoIP+ISDN: The gateway is configured to work both with the VoIP and ISDN PRI cards. **This mode is not supported by the firmware yet and may cause system malfunction!**

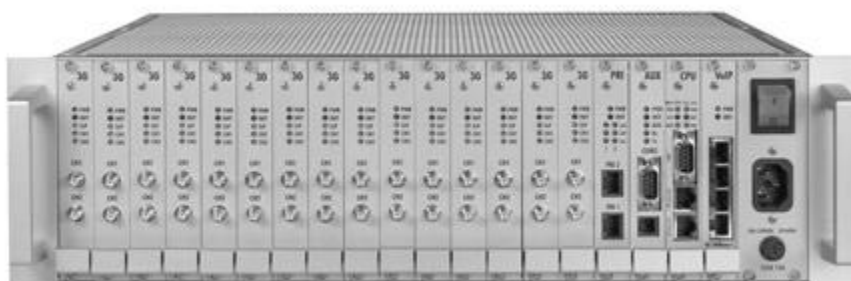

### Caution

- Wrong jumper positions may cause malfunction of the whole system! Please make changes only if the system is powered off!



### Note

- The jumper settings are identical for all the gateway types (2N<sup>®</sup> StarGate / BlueStar / BlueTower).

## 2.4 Installation

### Product Completeness Check

Before installing this product, check whether the delivery is complete according to the following packing list and read this manual thoroughly. The manufacturer cannot be held responsible for any damage incurred due to an incorrect use of this product in contradiction with this manual. The warranty terms do not cover damage to the product caused by rough handling, incorrect storage or exceeding the quoted technical parameters.

Basic packing list items:

Item	Rack with AC power supply	Rack with DC power supply
Power cable 2.5m	1	-
Mounting set	1	1
Software CD	1	1
Twisted cable for headset	1	1
Headset for test calls	1	1
Serial 9F-9F cable	1	1

Additional packing list items:

Included device	1PRI card	2PRI card	VoIP card	Basic CPU card	Enhanced CPU card
Ethernet cable 3m	1	2	1		
Ethernet cable 0.6m				1	2



#### Note

- The packing lists are the same for all the gateway types (2N<sup>®</sup> StarGate / BlueStar / BlueTower).

### Installation Conditions

The following conditions must be met during system installation:

- Appropriate location (enough free space);
- GSM / UMTS signal intensity (minimum recommended signal level: **-80dB**). You can use the NET monitor on a mobile phone (e.g. Nokia, Siemens) or the diagnostics screen in the configuration tool for measuring the GSM / UMTS signal intensity;

- Un-overloadable GSM / UMTS cells to which the gateway modules are logged in; please keep in mind that up to 30 calls are set up at a time during full traffic (according to the gateway configuration);
- No strong electromagnetic radiation is allowed on the system installation site;
- No strong electromagnetic reflections are allowed on the antenna installation site;
- The ISDN PRI connection must be configured properly and meet the ITU-T Q.931-EDSS1 and related recommendations;
- The VoIP – SIP signalling must meet the required RFCs;
- Place the gateway into an environment that complies with the gateway working conditions (an air conditioned room or installation rack);
- An appropriate (according to the power supply unit used) power feeding with overvoltage protection and an on-line UPS are recommended;
- An Ethernet connection on the installation site is advisable for comfortable gateway administration;
- All the SIM cards to be used must have the same PIN code (or deactivated PIN code) and be activated by the GSM / UMTS provider.



### Warning

- The outdoor antenna cable has to be connected according to the overvoltage protection and grounding safety rules.
- High temperatures on the installation site may cause short-time or permanent gateway errors!



### Warning

- Do not cover the top, bottom and rear sides of the gateway to avoid overheating and gateway error!
- Protection against humidity and extreme temperatures: The appliance may never be placed close to heat sources (radiators) or places exposed to direct sunshine. Also places with high humidity (such as bathrooms and cellars), places with significant temperature fluctuation (next to doors, windows), dusty places (workshops) and places exposed to aggressive gases (accumulator rooms, boiler rooms) as well as places with intensive vibrations and places exposed to shocks (compressor rooms, heavy industrial operations) should be avoided. The system should be installed horizontally.

## VoIP Connection

All the gateway types have the same features. The only difference lies in the number of simultaneous calls through the VoIP card.

<b>Voice codec support</b>	G.711u , G.711a , G.723 at 6.3/5.3bps , G.729
<b>Default RTP ports</b>	8000 – 8998 (adjustable by configuration tool)
<b>Supported signalling</b>	SIP

<b>Default IP port for signalling</b>	5060 (adjustable by configuration tool)
<b>STUN protocol</b>	Supported IP address check
<b>Interface for SIP</b>	10BaseT Ethernet interface on basic CPU card
<b>Interface for RTP streams</b>	10/100BaseT Ethernet interface on VoIP card
<b>Maximum number of simultaneous calls</b>	
<b>2N® StarGate</b>	30
<b>2N® BlueStar</b>	16
<b>2N® BlueTower</b>	8

The VoIP board is designed as a media gateway. It works only with media packets (RTP); signalling packets (SIP) must be routed to the basic CPU IP address.



### Tip

- You have to restart the VoIP card upon any VoIP setting change.



### Caution

- For a successful VoIP card initialisation, the VoIP board MAC address has to be filled in correctly and the basic CPU must be switched to the VoIP-SIP mode and contain the VoIP firmware file.
- The integrated Ethernet will not work until the VoIP card has been initialised successfully.

## ISDN PRI Connection

The gateway can contain a PRI card with one or two ISDN PRI interfaces (depends on the part number). PRI 1 is always set as an internal interface (PBX connection) and PRI 2 as an external interface (PSTN connection). The Least Cost Routing (LCR) and additional routing mechanisms are activated on the internal interface. All incoming calls to the external interface are always routed directly to the internal interface.

<b>Interface</b>	ISDN PRI (E1 frame)
<b>Signalling</b>	Q.931 – EDSS1
<b>Signalling channel (D-channel)</b>	16.
<b>Network interface type</b>	NT or TE (adjustable by configuration tool)*
<b>TEI number</b>	0 – 63 (adjustable by configuration tool)
<b>CRC on Layer 1</b>	Activated / deactivated (adjustable by configuration tool)*
<b>Connector type</b>	Switchable RJ45 (see Subs. 2.1)
<b>Supported voice codec</b>	G.711a**

**Supported B-channel services** Only voice\*\*

\*The PRI 2 interface is always of the opposite type than the PRI 1 interface.

\*\*Other streams are sent directly to the opposite PRI interface.

## Installation Examples

There is an exact time source for synchronisation of the PRI interface lines on the PRI board. Even if you have synchronisation problems on the installation site (caused by specific and probably ill-configured PBXs with more than one active PRI interfaces), there is a solution as shown below. Before using this solution you are recommended to configure your PBX properly, or use the DialThru function. Red lines are calls to the PSTN, orange lines are calls to GSM / UMTS networks.

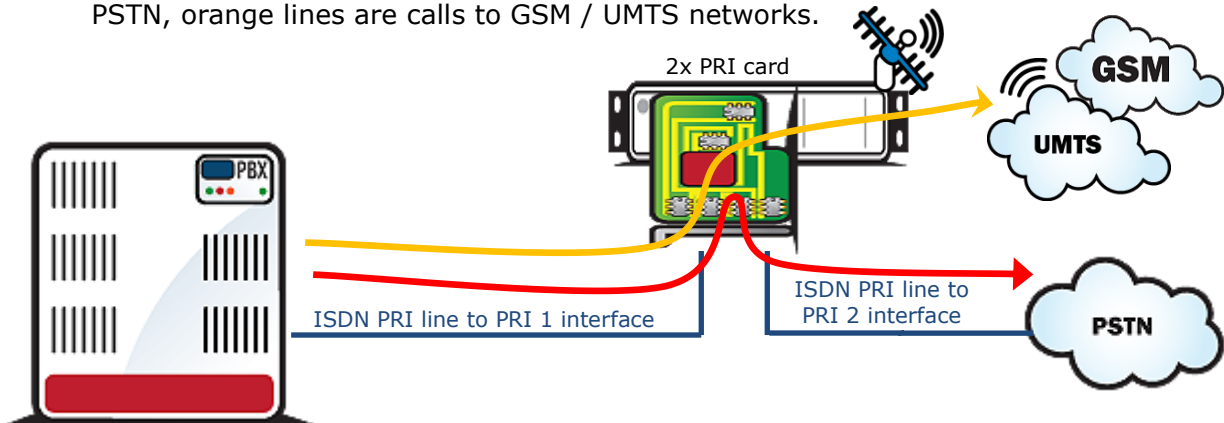

DialThru Function Installation

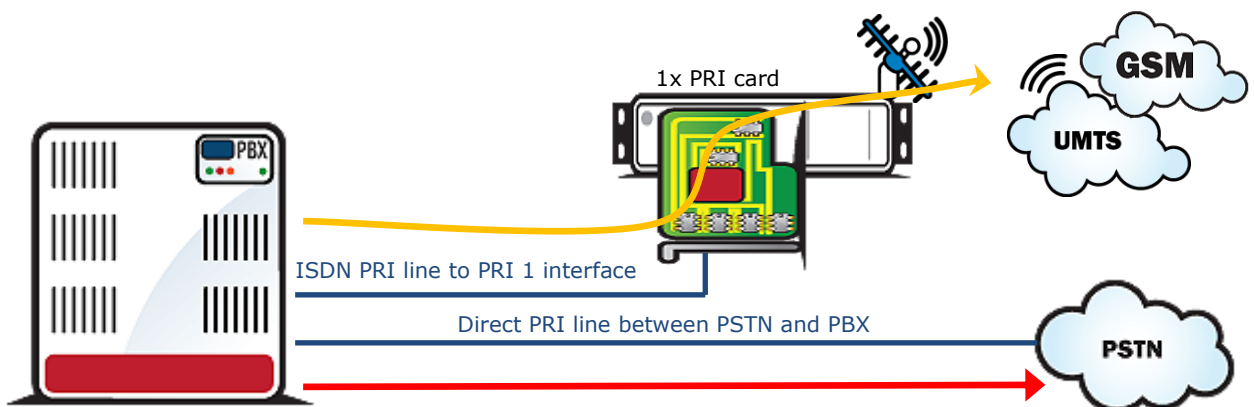

1ISDN PRI Card Installation

## External Synchronisation Option

There is an exact time source for synchronisation of the PRI interface lines on the PRI board. Even if you have synchronisation problems on the installation site (caused by



specific and probably ill-configured PBXs with more than one active PRI interfaces), there is a solution as shown below. Before using this solution you are recommended to configure your PBX properly, or use the DialThru function.

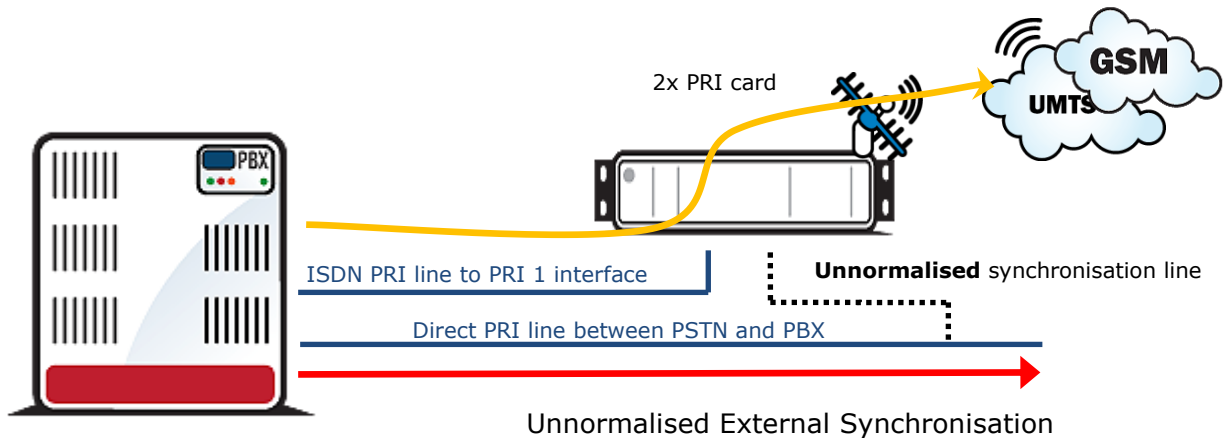

Connect only Tx wires to the 2PRI board because the ISDN PRI line is not designed for point-to-multipoint solutions (more than two devices on one ISDN line) like the BRI ISDN line. This solution is substandard! In case you detect a problem on the line between the PBX and PSTN (due to an additional connection to the PRI 2 interface), please disconnect PRI 2 from the line. These problems may be caused by changes in the line impedance.



### Note

- Connecting Tx wires only (from the PSTN point of view) to the PRI 2 interface has no influence on signalling and voice calls. The PRI board just takes synchronisation pulses from the line.



### Tip

- For an external synchronisation line you can use a standard cable with an RJ45 connector. To disconnect the Rx wires just release the defined jumpers on the PRI 2 interface on the PRI board.

## Licence Limitations

Some of the 2N products have time-limited software licences (e.g. DSS1 signalling, etc.). Moreover, every gateway restart adds one hour to the internal licence counter. To see the current licence status, use the configuration tool or the eCPU web interface (the standard licence validity is 850 hours).

You are recommended to contact your dealer before licence expiration to request for a new licence key to increase the gateway using time.

To upload a new licence code, use the eCPU web interface or the configuration tool (locally or remotely).





### Caution

- A gateway with an expired licence fails to accept calls from the VoIP/GSM/UMTS/PRI interface because the call control layer is deactivated.

## GSM / UMTS Network Restriction

Upon the dealer's request, 2N can activate restrictions of use for selected wireless networks only. Thus, the gateway will be unable to log in successfully to the restricted wireless networks. This state is signalled by the red status LEDs on the GSM / UMTS cards and the 'netw-err' message on the configuration tool diagnostics screen.



### Tip

- To prevent this problem consult ask your dealer.

## Basic CPU Firmware

Before installing your 2N<sup>®</sup> StarGate / BlueStar / BlueTower gateway, please upload new firmware to both the CPUs. Find the latest firmware version plus all software on the enclosed CD or on our website [www.2N.cz](http://www.2N.cz) .

Firmware upgrade for the basic CPU board (for eCPU please use the web interface and the dedicated web section):



### Warning

- To avoid gateway error please use only the firmware files that are designed for your type of gateway and certified by 2N.

#### Via a local serial port:

- Connect your PC to the gateway (COM1 or COM2) via RS232 (serial port).
- Prepare the firmware-containing file into a folder selected by you (*Pxxxx-V-xx.xx.xx.hex*).
- Run the configuration tool, which you find on the 2N web pages or on an enclosed CD.
- Choose the **Firmware/Licence** item in the **Gateway control** section.
- Choose the **Firmware file** containing the new firmware (*Pxxxx-V-xx.xx.xx.hex*).
- Click on the **Upgrade firmware through COM** button.
- The program now automatically uploads your new firmware (it takes about 2 minutes).

**Caution**

- Do not interrupt the program and serial connection during upgrading to avoid a firmware upgrade error.
- If the upgrading procedure is interrupted, please switch the gateway on and off, restart the configuration tool and retry to upload the firmware.

**Note**

- The gateway will make reset during the procedure (to disconnect all proceeding calls).
- The gateway is in the boot state during firmware upgrading over a serial port.

**Remotely via Ethernet:**

- Run the configuration tool.
- Choose the **Firmware/Licence** item in the **Gateway control** section
- Choose the **Firmware file** containing the new firmware (Pxxxx-V-xx.xx.xx.hex)
- Click on the **Upgrade firmware through Ethernet** button.
- The configuration tool now automatically uploads the new firmware (it takes about 30 seconds). After a successful upgrade, the gateway will restart automatically.

**Note**

- The remote gateway firmware upgrade is supported only by the CPU with bootware version 2.52 or higher and firmware version 2.30.01 or higher.
- The basic CPU card has to be connected to the Ethernet network.

**Tip**

- You can upgrade the basic CPU firmware also from the eCPU web interface. You can also use 2N<sup>®</sup> SIM Star Server for remote upgrades for all connected gateways.

## Potential Problems of GSM / UMTS Networks

The 2N gateway works reliably even under a 100% load. The following problems may be caused by GSM networks:

- ❓ *Wireless modules cannot log in, log in slowly, or log out occasionally. This problem may be caused by any of the following situations:*

- ◆ The GSM / UMTS signal is low. We recommend the minimum signal level of approximately -80dBm. If lower, you have to change the antenna or gateway location!
- ◆ The GSM / UMTS cell (BTS) to which the wireless module is trying to log in is overloaded. If you use directional antennas, you can direct them to more GSM cells than one. The possibility to choose a cell by antenna directing is considerably limited or eliminated in towns or densely populated areas where multiple signal reflections occur. It is also difficult to select a cell where the cells lie in a straight line before and behind the antenna. If no selection can be made, you have to use another available GSM / UMTS provider.



### Caution

- You are recommended to use 32 channels at most on one installation site for one GSM / UMTS provider to avoid wireless network overload problems on the installation site.

- ◇ *Some wireless modules are permanently logged-out from the network or fail to receive incoming calls:*
  - ◆ The problem indicates a wireless network overload due to heavy traffic. You can eliminate this problem by setting the **GSM basic parameters - Call delay** parameter in the configuration tool to '2 seconds'. This parameter extends the delay between the end of one call and the start of another call made via one and the same wireless module.
- ◇ *Some wireless modules cannot log in to the wireless network even after reset:*
  - ◆ Your GSM / UMTS provider may have located the SIM card, but refused the login to the wireless network because either too many calls are being made using this card, or the SIM card has been logged-in to one BTS for too long. This problem can be solved by an occasional exchange of SIM cards between wireless modules.

The manufacturer cannot be held responsible for any SIM card or service blocking problems of the GSM / UMTS provider caused by the GSM / UMTS provider's breach of a SIM card term agreement.

## Mounting

2N recommends installing the gateway in a well ventilated area (rack) according to the installation conditions. The 2N® StarGate and BlueStar gateways are designed for rack installation with the minimum rack depth of 400mm and 3U (132mm). 2N® BlueTower is to be installed into a rack shelf.

To prevent gateway overheating, you are recommended to install the gateway into a rack with 1U free and uncovered space above and below the gateway (see the figures below):

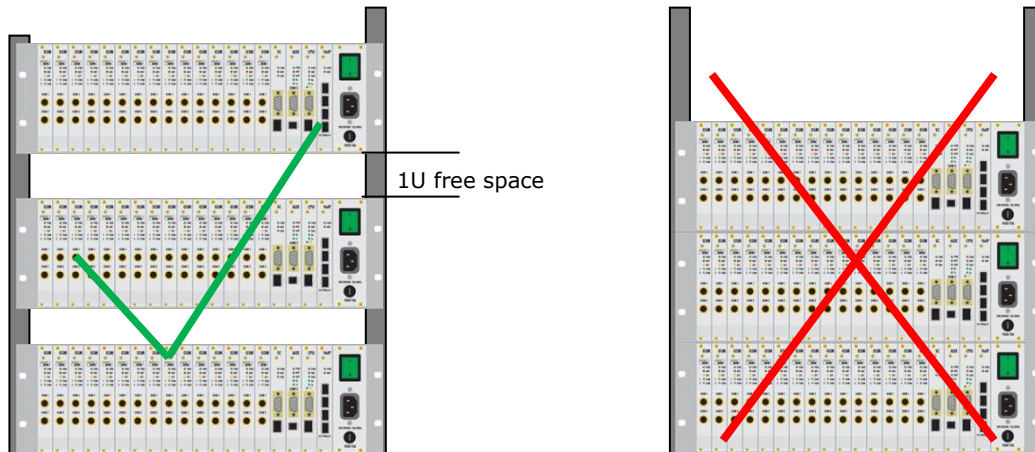

### Warning

- Do not cover the top, bottom and rear sides of the gateway to avoid overheating and gateway error!
- Protection against humidity and extreme temperatures: The appliance may never be placed close to heat sources (radiators) or places exposed to direct sunshine. Also places with high humidity (such as bathrooms and cellars), places with significant temperature fluctuation (next to doors, windows), dusty places (workshops) and places exposed to aggressive gases (accumulator rooms, boiler rooms) as well as places with intensive vibrations and places exposed to shocks (compressor rooms, heavy industrial operations) should be avoided. The system should be installed horizontally.

## Main Installation

- Place the gateway into an environment that complies with the gateway working conditions.
- Configure the gateway properly using the configuration software included.
- The gateway mains supply must be backed-up and overvoltage-protected (a line-interactive or on-line UPS is recommended).
- Any of the available remote control tools (ISDN line, analogue line, Ethernet) are advised for a more comfortable gateway administration.

## Control Ways

The system can be supervised and controlled locally or remotely as follows:

- Local control using a PC connected by a standard full crossed serial cable;
- Remote control using an analogue or ISDN modem connected to COM2 located on the AUX board;

- Remote connection over the IP network using the Telnet protocol or web interface (for the eCPU);
- Remote connection over a data call to the ISDN PRI interface.\*

 \* An optional part. See Subs. 2.1 – PRI Board for additional information.

---

## Configuration Ways

---

The system can be configured by any of the following ways:

- Using extended AT commands (refer to Subsection **Chyba! Nenalezen zdroj odkazů.**);
- Using the configuration tool GUI from a CD (Section 3);
- Using the eCPU web interface.\*

 \* An optional part. See Subs. 2.1 – eCPU Board for additional information.



# 3

# Configuration

This section describes configuration of the **2N® StarGate / BlueStar / BlueTower** product.

Here is what you can find in this section:

- Important Default Settings
- Quick Step-by-Step Manual
- System Upgrade
- Configuration Tool
- Enhanced CPU Configuration
- 2N® External Routing Machine Configuration
- 2N® SIM Star System
- Voice CallBack Centre Configuration

## 3.1 Important Default Settings

The following table shows the default values of important parameters:

Parameter	Value
<b>IP address of basic CPU</b>	192.168.1.100
<b>IP mask of basic CPU</b>	255.255.255.0
<b>IP address of VoIP board</b>	192.168.1.101
<b>IP mask of VoIP board</b>	Same as basic CPU configuration
<b>IP address of enhanced CPU</b>	By DHCP server
<b>IP mask of basic CPU</b>	By DHCP server
<b>Username / Password of basic CPU</b>	2n / 2n
<b>Username / Password of enhanced CPU</b>	Admin /
<b>Username / Password of ERM</b>	erm / ermserver



### Caution

- To prevent unauthorised access please change the default access username and password as soon as possible!



## 3.2 Quick Step-by-Step Manual

The following quick guide is intended for installation of a gateway with basic features only. For full configuration please read the whole user manual carefully. For a successful installation of the whole system we recommend to have a training certificate from 2N.



### Warning

- All SIM cards must have the same or disabled PIN code! The same PIN code must be defined in the gateway configuration.

## Quick Step-by-Step Manual for ISDN PRI Card

The following steps are proposed for 2N® StarGate / BlueStar / BlueTower with a 1PRI/2PRI board.

1. Install the gateway into a system rack as mentioned in Subsection 2.4 – Mounting.
2. Insert the SIM cards to the GSM / UMTS boards. All the SIM cards must have the same or disabled PIN code. For the SIM holder positions on the GSM / UMTS board refer to Subs. 2.1 – GSM / UMTS Board.
3. Connect the PBX PRI line to PRI 1 on the ISDN PRI card. Connect the PSTN PRI line to PRI 2 on the ISDN PRI card. For the PRI board hardware configuration refer to Subs. 2.1 – PRI Board. For examples of a correct connection see Subs. 2.4 – ISDN PRI Connection.
4. Interconnect your PC with the gateway using the attached serial cable. Use COM1 located on the gateway CPU card.
5. Install and run the configuration tool. It is located in the **GSM Gateways-ISDN PRI** section on the enclosed CD.
6. In the top menu open **Settings>Communication settings** and set **Communication type** to **Serial communication**. In the **Serial port** item set the **COM port** number that you are using for communication with the gateway (for details see Section 3.4 Gateway Connection). Now click on **OK**.
7. In the top menu click on **Gateway>Connect**. Press **Yes** in the following dialogue and wait for configuration download from the gateway.
8. Move to the **Gateway configuration>System parameters** section.
9. To use remote control over TPC/IP, change the **IP address**, **Subnet mask** and **IP router** parameters.
10. In case you are using SIM cards with an active PIN, use the same PIN for ALL of the SIM cards used. Fill in the same PIN code into the **PIN** parameter too.

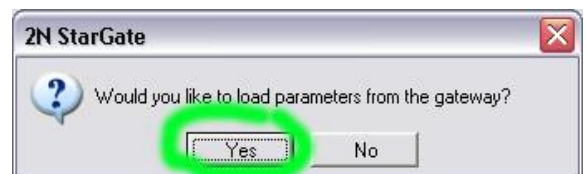

11. Change the **Configure gateway as** parameter to **ISDN-DSS1**. Click on the **Save to gateway** button located below the configuration parameters to save all the configuration parameters from the current window into the gateway.
12. Move to the **ISDN parameters** section. Here set the PRI 1 and PRI 2 interfaces. To do so correctly, please read Subs. 2.1 – PRI Board carefully. Having finished setting, click on the **Save to gateway** button.
13. In the **GSM group assignment** section assign all the wireless modules to the incoming and outgoing group 1 and then save the settings to the gateway using the **Save to gateway** button.
14. In the **GSM outgoing groups – GSM group 1** section set the following parameters:
  - a. SIM card switching mode = SIM 1;
  - b. CLIR = default;and save the settings into the gateway.
15. In the **LCR table** add a new line with the following parameters: NetworkID=Group 1, Groups=GSM group 1, PRI 2. Save the new table to the gateway using the **Save to gateway** button.

Now the gateway is prepared for accepting all calls from the PRI 1 interface and route them to the GSM / UMTS network. When all the wireless modules are busy, the gateway will reroute calls to the PRI 2 interface. All calls from the GSM / UMTS network will be rejected. All calls from the PRI 2 interface will be rerouted to PRI 1.

Should you have a problem with the correct function, please read this manual carefully and check all parameters. For additional questions refer to the 2N® FAQ at <http://faq.2n.cz>. For a successful installation of the whole system we recommend you to have a training certificate from 2N.

## Quick Step-by-Step Manual for VoIP Card

The following steps are proposed for 2N® StarGate / BlueStar / BlueTower with a VoIP board.

1. Install the gateway into a system rack as mentioned in Subsection 2.4 – Mounting.
2. Insert the SIM cards to the GSM / UMTS boards. All the SIM cards must have the same or disabled PIN code. For the SIM holder positions on the GSM / UMTS board refer to Subs. 2.1 – GSM / UMTS Board.
3. Interconnect your PC with the gateway using the attached serial cable. Use COM1 located on the gateway CPU card.
4. Install and run the configuration tool. It is located in the **GSM Gateways-ISDN PRI** section on the enclosed CD.
5. In the top menu open **Settings>Communication settings** and set **Communication type** to **Serial communication**. In the **Serial port** set the COM port number that you are using for communication with the gateway (for details see Section 3.4 Gateway Connection). Now click on **OK**.
6. In the top menu click on **Gateway>Connect**. Press

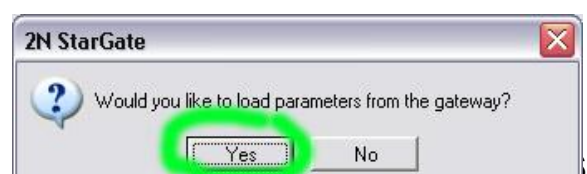

**Yes** in the following dialogue and wait for configuration download from the gateway.

7. Move to the **Gateway configuration>System parameters** section.
8. To use remote control over TPC/IP, change the **IP address**, **Subnet mask** and **IP router** parameters.
9. In case you are using SIM cards with an active PIN, use the same PIN for ALL of the SIM cards used. Fill in the same PIN code into the **PIN** parameter too.
10. Change the **Configure gateway as** parameter to **ISDN-DSS1**. Click on the **Save to gateway** button located below the configuration parameters to save all the configuration parameters from the current window into the gateway.
11. Move to the **VoIP parameters** section. Here you set the proper configuration for the VoIP SIP line. Fill in the IP address to be assigned to the VoIP board into the **VoIP card / MGCP gateway** parameter. To do so correctly, read Subsections 2.1 – VoIP Board and 2.4 – VoIP Connection carefully. Having finished setting click on the **Save to gateway** button. Note: All the VoIP card settings will be activated after the gateway restart!
12. Connect the Ethernet line to the Ethernet switch located on the VoIP card. Then interconnect the basic and enhanced CPUs with the VoIP card Ethernet switch (for description of the CPU board see Subs. 2.1 – Basic CPU, Enhanced CPU).
13. In the **GSM group assignment** section assign all the wireless modules to the incoming and outgoing group 1 and then save the settings to the gateway using the **Save to gateway** button.
14. In the **GSM outgoing groups – GSM group 1** section set the following parameters:
  - a. SIM card switching mode = SIM 1;
  - b. CLIR = default;and save the settings into the gateway.
15. In the **LCR table** add a new line with the following parameters: NetworkID=Group 1, Groups=GSM group 1, PRI 2. Save the new table to the gateway using the **Save to gateway** button.

Now the gateway is prepared for accepting all calls from the VoIP-SIP interface and route them to the GSM / UMTS network. When all the wireless modules are busy, the gateway will reject the call. All calls from the GSM / UMTS network will also be rejected.

Should you have a problem with the correct function, please read this manual carefully and check all parameters. For additional questions refer to the 2N<sup>®</sup> FAQ at <http://faq.2n.cz>. For a successful installation of the whole system we recommend you to have a training certificate from 2N.

## Quick Step-by-Step Manual for 2N<sup>®</sup> SIM Star

The configuration of the whole gateway is similar to that of a normal stand-alone gateway but you have to make two extra steps:

1. Fully configure the enhanced CPU (see Section 3.5 ).
2. Activate the **SIM Client** process in the enhanced CPU web interface management windows.

## 3.3 System Upgrade

The 2N® StarGate / BlueStar / BlueTower gateway contains three types of software to be constantly updated. Please refer to the 2N web pages for download of the latest firmware version for your system.



### Warning

- To avoid system error, use only the firmware files that are designed for your type of gateway and certified by 2N.

#### Basic CPU

The basic CPU is the main system CPU (see Subs. 2.1 – Basic CPU Board) used for upgrading the P2005-V-02.XX.XX files (XX stands for the version number). You can upgrade this CPU locally via an RS232 or remotely via the TCP/IP. For the upgrading procedure refer to Subs. 2.4 – Basic CPU Firmware.

Find the latest firmware version in the status line of the connected configuration tool or via the eCPU web interface (**PRI Gateway** section).

#### Enhanced CPU

The enhanced CPU (see Subs. 2.1 – Enhanced CPU Board) gives the gateway new advanced features and a web interface. This unit has extra firmware, which can be upgraded via the web interface in the **Management – Firmware** section. The eCPU firmware files are in the PGW-0-X-XX format (XX stands for the version number). Please keep in mind that the typical size of the eCPU firmware is about 10MB. It is important for upgrading through a narrow bandwidth line.

Find the latest firmware version on the web interface home page.

#### VoIP Card Firmware

An independent DSP CPU located on the VoIP card automatically downloads own firmware from the basic CPU storage. You can upgrade this firmware only via the configuration tool connected to the basic CPU via TCP/IP. The upgrading procedure is similar to that for the basic CPU. The firmware format is SECUREDmxxx.out (XXX stands for the version number).

Find the latest firmware version in the VoIP card diagnostics window in the configuration tool (see Section Gateway Control Menu ).

## 3.4 Configuration Tool

The 2N® StarGate / BlueStar / BlueTower gateway configuration tool helps you configure and monitor the gateway remotely or locally. The configuration tool automatically recognises the system type and modifies the parameters accordingly.

### Program Installation

The configuration tool is located in the **GSM Gateways-ISDN PRI** section on the enclosed CD. Please install it onto your local drive.

The configuration tool is designed for the MS Windows XP SP2 EN OS with the normal text size.

### Program Running

Once the installation is complete, run the program by clicking on the **PRIGW program** in your PC menu or on the icon on your desktop, or by starting the **PRI program.exe** file, which can be found on the appropriate location installed by you using a file explorer, commander or browser.

**Having started the program, you can use:**

- the main menu;
- the button bar menu (included in the main menu too);
- the card (folder) menu:
  - **Topics** with configuration items divided into on and off-line sections;
  - **Alphabetical glossary** with configuration items arranged in the alphabetical order;
- the configuration item editing window.



## Gateway Connection

The configuration tool can provide the gateway connection either locally via a serial line (RS232) or remotely via the TPC/IP – Telnet protocol or via a modem. To select the type of connection, use the **Setting > Communication settings** section.

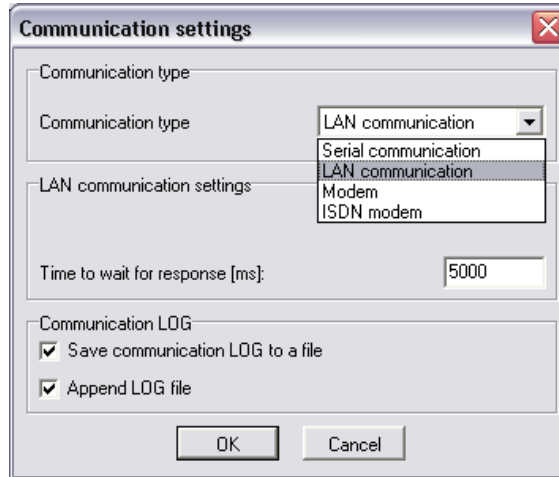

After selecting the required connection type, click on **OK** to select the proffered type of connection.

To establish connection with the gateway, click on the gateway connecting icon, or press the F8 key, or use the **Gateway > Connect gateway menu**.



After a successful connection, the program will ask you for automatic downloading of the configuration file from the connected gateway.



### Tip

- Click on the **on-line configuration** item in the **Gateway control** section to make the configuration tool automatically try to establish connection with the gateway according to the selected connection type.
- If you are servicing more than one gateway, follow the instruction in Section Gateway Menu.



### Note

- The Telnet IP port on the gateway is always set to 23.
- The transmission rate of the basic CPU's RS232 is always set to 57,600bps.

## Main Menu and Button Bar

The following menus are available here:

- **File**  
for physical work with the configuration file  
(for saving and loading see Section File Menu);
- **Gateway**  
for connection/disconnection with one or more gateways  
(for detail see Section Gateway Menu);
- **Gateway control**  
gateway operating commands  
(for diagnostics, reset, DISA, etc. see Section Gateway Control Menu);
- **Settings**  
communication settings and language selections;
- **Help**  
information about the configuration tool version.

## File Menu



Use this menu to work with the gateway configuration (default unnamed.ini) file or default configuration file, i.e. load, save, etc... The menu contains a program closing item too.

- **Load**  
loads the last-saved configuration file from the configuration tool directory. Or requires loading of default settings upon the first run.
- **Save**  
saves the current settings into the file in the configuration tool directory (or into a folder defined in the **Gateway list** – refer to Gateway Menu0).
- **Load from disk ...**  
loads a file from a folder selected by you.
- **Save as ...**  
saves a file into a folder selected by you.
- **Default settings**  
loads the preset default configuration.
- **Close**  
terminates the program.



## Gateway Menu



The **Gateway** menu is used for connecting/disconnecting the gateway. You can select a gateway from the **Gateway list** for remote control.

- **Connect gateway**  
interconnects the gateway with your PC and establishes mutual communication via an RS232 serial interface using the Telnet protocol, or via a modem connection.
- **Disconnect gateway**  
disconnects the gateway and discontinues its communication with your PC.

If you communicate with more gateways than one, you are advised to have each configuration file in a different directory to avoid unintentional rewriting of the configuration file by another gateway configuration. To do this, use the **Gateway list** item.

- **Gateway List**

Select gateway from list – select a gateway (directory with the configuration file) to be connected to the PC.

Connect gateway from list – get connected to the selected gateway.

Gateway list – edit the list of gateways including directories.

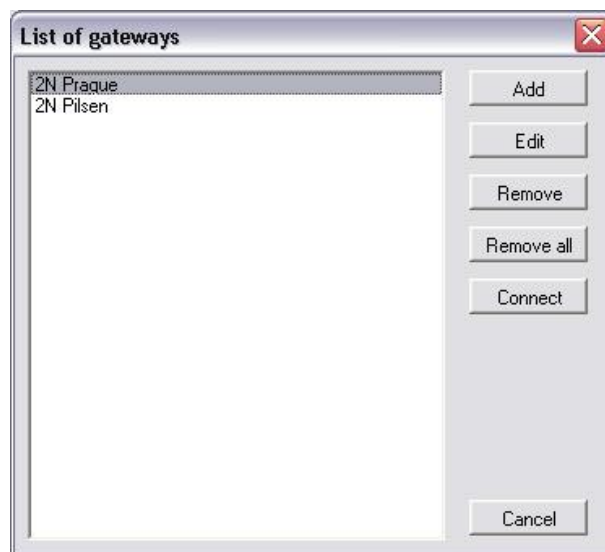

**Note**

- Set the **Settings > Communication settings** to select the required type of connection.

## Gateway Control Menu

The **Gateway control** menu contains the on-line gateway configuration and control commands. These commands are available only if the gateway is connected.

**Note**

- When the selected board is not inserted, the status line will show the board type = NONE and status = UNDEF.

**Tip**

- Click on the **On-line configuration** item in the **Gateway control** section to make the configuration tool automatically try to establish connection with the gateway according to the selected connection type.

---

## Diagnostics

---

With this screen you can see the current state of each GSM / UMTS wireless engine (GSM / UMTS board), the PRI boards and also the VoIP board.

The GSM / UMTS boards also provide buttons for on-line direct control of the selected wireless engine (e.g. restart, block etc.). A similar restart operation can be made with the defined plug-in board.

**Tip**

- The **Sleep** button on the GSM / UMTS boards is designed for an easy SIM card exchange under heavy call traffic. If this function is activated, the gateway does not use the selected GSM / UMTS board for a new outgoing call, but keeps the active call via the board. This state is signalled by a flashing green power LED located on the board. To remove the sleep mode reset the board.

For description of the statuses refer to Subs. 4.2 - List of Status Codes.

### 1PRI and 2PRI Board

- Board type and status;
- Statuses of ISDN PRI layers 1–3 (both PRI interfaces);
- PRI 1 and PRI 2 modes (e.g. NT/M);
- Voice B-channel statuses (both PRI interfaces).

Diagnostics

PRI	VolP	0	1	2	3	4	5	6	7	8	9	10	11	◀ ▶
-----	------	---	---	---	---	---	---	---	---	---	---	----	----	-----

Board status :  
 Board type : **PRI131**      Status : **OK**         

Detailed description :  
 Layer 1 : **DEACT**      Layer 2 : **NOTEI**      Layer 3 : **NULL**  
 PRI 1 (in mode) : **NT/M**  
 Status of B-channels :

01-10	NULL	NULL	NULL	NULL	NULL	NULL	NULL	NULL	NULL	NULL	NULL
11-20	NULL	NULL	NULL	NULL	NULL	NULL	NULL	NULL	NULL	NULL	NULL
21-30	NULL	NULL	NULL	NULL	NULL	NULL	NULL	NULL	NULL	NULL	NULL

---

Layer 1 : **DEACT**      Layer 2 : **NOTEI**      Layer 3 : **NULL**  
 PRI 2 (in mode) : **TE/S**  
 Status of B-channels :

01-10	NULL	NULL	NULL	NULL	NULL	NULL	NULL	NULL	NULL	NULL
11-20	NULL	NULL	NULL	NULL	NULL	NULL	NULL	NULL	NULL	NULL
21-30	NULL	NULL	NULL	NULL	NULL	NULL	NULL	NULL	NULL	NULL

### VoIP Board

- Board type and status;
- Firmware version downloaded into the VoIP board;
- Maximum number of licenced voice channels;
- Status of voice channels.

### GSM / UMTS Board

- Board type and status;
- Statuses of layers 2 and 3, statuses of the module communication layers;
- GSM network - name of the network where the module is currently logged in;
- Network ID - ID number of the network (MCC+MNC) where the module is currently logged in;
- GSM cell - identification number of the GSM cell the module is currently logged in to. Displayed code numbers in the A,BBB,CCC,DDDDD format are received from the wireless engine:

**A**= Status of wireless part:

0 – The wireless engine is currently not registered;

1 – The wireless engine is registered to the home network;

2 – The wireless engine is not registered, but is searching for a new provider;

3 – The wireless engine registration was denied by the network;

4 – The unknown reason;

5 – The wireless engine is registered to a roaming network;

**BBB** = LAC (Location Area Code) first byte in DEC format;

**CCC** = LAC second byte in DEC format;

**DDDDD** = cell identification code;



### Note

- Registration to a roaming network is restricted by default. For roaming enable refer to Subs. 2.4 - Installation.
- Upon the dealer's request, 2N can activate the restriction of use for selected wireless networks only. Thus, the gateway will be unable to log in successfully to the restricted wireless networks. This state is signalled by the red status LEDs on the GSM / UMTS cards and the 'netw-err' message on the configuration tool diagnostics screen.

- Number of used Outgoing / Incoming GSM groups;
- Number of active SIM card positions;
- Module ID - wireless engine international identification number (IMEI);
- Rev ID – wireless engine module firmware revision number;

- ID SIM card # - international identification number (IMSI) or SIM serial number (SCID) of the SIM card in holder position #;
- Signal intensity - current signal level in the network where the module is logged in (minimum = -113 dBm – the module is logged out);
- Sleep button for sleep function activation on a selected board; used for switching a selected board into the sleep mode;
- Block button for manual blocking of a selected wireless module; the module transits into a mode where it will be unable to receive any incoming or incoming call;
- Down button for automatic blocking of a module after the call end;
- Reset button for manual restarting of a selected wireless engine;
- Clear credit button for clearing of call statistics of a selected wireless engine;
- On button for power-on of a blocked wireless engine.

---

## Info on Current Calls

---

This window provides information on currently active calls. The information can be arranged according to the GSM module or the B-channel. Or you can show only PRI 1 <> PRI 2 calls or all calls unsorted.

The screenshot shows a window titled "Info about actual calls" with four radio buttons for sorting: "Arrange by B-channel number" (selected), "Arrange by number of GSM module", "All calls on connecting layer (not sorted)", and "Calls from PRI 1 to PRI 2 by PRI 2". Below the buttons is a table with columns: cha-layer3, cc-layer4, cha-layer3, and durat. The table lists call identifiers from p00-NULL to p31-NULL with corresponding duration values (---:--).

cha-layer3	cc-layer4	cha-layer3	durat.	cha-layer3	cc-layer4	cha-layer3	durat.
p00-NULL			---:--	p01-NULL			---:--
p02-NULL			---:--	p03-NULL			---:--
p04-NULL			---:--	p05-NULL			---:--
p06-NULL			---:--	p07-NULL			---:--
p08-NULL			---:--	p09-NULL			---:--
p10-NULL			---:--	p11-NULL			---:--
p12-NULL			---:--	p13-NULL			---:--
p14-NULL			---:--	p15-NULL			---:--
p16-NULL			---:--	p17-NULL			---:--
p18-NULL			---:--	p19-NULL			---:--
p20-NULL			---:--	p21-NULL			---:--
p22-NULL			---:--	p23-NULL			---:--
p24-NULL			---:--	p25-NULL			---:--
p26-NULL			---:--	p27-NULL			---:--
p28-NULL			---:--	p29-NULL			---:--
p30-NULL			---:--	p31-NULL			---:--

---

## Connection Status

---

Shows the current statuses of all possible remote/local control ways of the gateway.

---

## Buffer Status

---

Shows the current status of the Call Data Records (CDR) memory. You can also check the **Mem** LED indicator on the basic CPU for an approximate state of the buffer.

The maximum capacity is over 100,000 records for PRI gateways and 50,000 records for VoIP gateways (the memory is shared with the VoIP card firmware).



### Tip

- You can increase the memory capacity by using the enhanced CPU with an SD card memory. For details see Subs. 2.1 Enhanced CPU Board.

---

## Tracing

---

The window helps save debug traces about the complete statuses of the connected gateway. With this tracing you can see the complete ISDN, VoIP and GSM signalling messages and active calls.



### Note

- Tracing can be activated only for one session at a time. The other sessions receive a BUSY message if requesting for tracing.
- The debug trace is on-line generated for a defined session; there is no memory to save the history. There is also a limit for the lines sent per second. If the data exceed the limit, the [FULL] message is sent.



### Tip

- For a detailed debug trace refer to the options shown in the figure below.

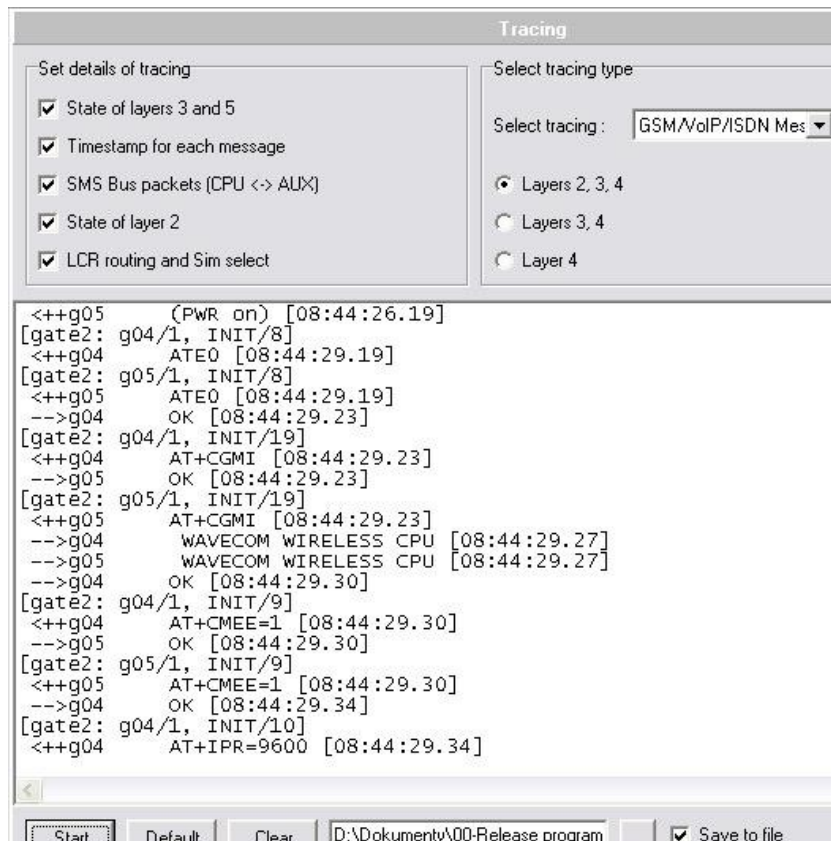

## GSM Monitor Info

This window gives you a direct answer about the current BTS where the GSM module is logged in. This information is available only on the Cinterion modules.

Description of response parameters from the TC35i module:

Chann	ARFCN (Absolute Frequency Channel Number) of the BCCH(THC) carrier. If chann is h, BTS supports hopping during connection.
Rs	RSSI (Received Signal Strength) of the BCCH carrier from 0 to 63. The indicated value is composed of the measured value in dBm plus an offset. This is in accordance with the formula specified in 3GPP TS05.08.
dBm	Receiving level of the BCCH carrier in dBm
PLMN	PLMN ID code
LAC	Location Area Code (HEX)
Cell	Cell ID code (HEX)
NCC	PLMN colour mode
BCC	Base station colour mode
PWR	Maximum power level used on RACH channel in dBm or current power level
RXLev	Minimum receiving level (in dBm) to allow registration
C1	Coefficient for base station selection
TS	Timeslot number
timAdv	Timing advance in bits
Q	Receiving quality (0-7)

---

Chmod	Channel mode (S_HR: Half rate, S_FR: full rate, S_EFR: enhanced full rate)
-------	--

---

## Statistics

The 2N® StarGate / BlueStar / BlueTower gateway automatically generates statistics about all incoming / outgoing calls. These data are used for automatic SIM card switching, Least Cost Routing, and so on. Statistics can be reset automatically (if preconfigured) or saved and deleted by the configuration tool (**Load and Delete**). To read all call statistics use the **Load from gateway** button. For a detailed description of the statistic data refer to Subs. 4.5.

## Firmware / Licence

With this window you can upgrade the basic CPU and VoIP card firmware.



### Warning

- To avoid gateway error use only the firmware files that are designed for your type of gateway and certified by 2N.

### Basic CPU

The basic CPU is the main system CPU (see Subs. 2.1 – Basic CPU Board) used for upgrading the P2005-V-02.XX.XX files (XX stands for the version number). You can upgrade this CPU locally via an RS232 or remotely via the TCP/IP. For the upgrading procedure refer to Subs. 2.4 – Basic CPU Firmware.

Find the latest firmware version in the status line of the connected configuration tool or via the eCPU web interface (**PRI Gateway** section).

2N StarGate M112-0905520003, Limit : No limit, Protocols : DSS1 SIP TUN , Networks : All, CPU112, SW : 02.52/02.30.02117		
Serial number	Current licence state	Bootware/Firmware version

### VoIP Card Firmware

An independent DSP CPU located on the VoIP card automatically downloads own firmware from the basic CPU storage. You can upgrade this firmware only via the configuration tool connected to the basic CPU via TCP/IP. The upgrading procedure is similar to that for the basic CPU. The firmware format is SECUREDmxxx.out (XXX stands for the version number).

Find the latest firmware version in the VoIP card diagnostics window in the configuration tool.

To add the two firmware types and a new licence file use the window below.



Section for firmware upgrade to basic CPU or VoIP card

Firmware/Licence

Firmware

Firmware version :

Bootware version :

Firmware file :

Information for gateway licence

Active?

Gateway limitation :

Licence status :

Networks :

Gateway unlock

Licence key for gateway :

Upgrading the basic CPU firmware or entering a new licence avoids restarting of the whole gateway.

Licence code	Description
DSS1	Licence for ISDN DSS1 signalling layer
SIP	Licence for VoIP-SIP signalling layer
TUN	Licence for direct access to wireless modules



**Caution**

- Be sure to use original and undamaged firmware files for the firmware upload to avoid gateway malfunction! For the latest firmware version see our websites ([www.2n.cz](http://www.2n.cz)).

## Time and Date

With this window you can change the current time and date of the basic CPU.



**Note**

- The enhanced CPU must be synchronised from the basic CPU or a public NTP server.
- If you use 2N<sup>®</sup> SIM Star, 2N<sup>®</sup> SIM Star Server will automatically synchronise all the connected gateways according to the basic CPU.

## Login Account

With this window you can enter a new access username and password for access via the TCP/IP – Telnet and ISDN PRI interfaces.



### Note

- For security reasons it is impossible to change the username and password in the case of TCP/IP – Telnet connection.
- For the system default settings refer to Subs. 3.1.



### Caution

- To prevent unauthorised access change the default access username and password as soon as possible!

## Voice Message

This window is used for uploading voice messages to the AUX board. Voice messages can be uploaded only locally via a serial port directly to the AUX board. Before uploading a voice message switch on the AUX board mode, refer to Subs. 2.1 – AUX Board.

You can use the following types of voice messages:

Type of message	Use	Maximum length (sec)
<b>DISA message</b>	Incoming calls from GSM/UMTS	64
<b>Connection message #1</b>	Outgoing calls via GSM group 1	8
<b>Connection message #2</b>	Outgoing calls via GSM group 2	8
<b>Connection message #3</b>	Outgoing calls via GSM group 3	8
<b>Connection message #4</b>	Outgoing calls via GSM group 4	8
<b>PRI 2 message</b>	Message to PRI 2 in case of deactivated PRI 1	16

Parameters of voice files: codec ISDN aLAW, 8kHz, mono.



### Note

- The PRI 2 connection message will be played only if the B-channel is opened.

## Test Calls

The 2N® StarGate / BlueStar / BlueTower gateway supports test calls via an analogue interface located on the AUX board (Subs. 2.1 – AUX Board). With an attached headset connected to the AUX board you can generate outgoing calls to the PRI, VoIP, or GSM/UMTS interface. It is also possible to connect an incoming call from a defined interface to the analogue interface.

The gateway will automatically generate debug traces in the case of active test call. This debug information can automatically be saved to a text file for later retrieval.

**Test calls**

Test call from AUX test interface :

- Rotating B-channels
- Via B-channel number
- Via GSM module number
- Connect 2 GSM modules

Called number :

2nd called number :

Limit : (0=off)

To GSM (according to called prefix)

Connect following incoming call :

- First incoming call from ISDN
- Incoming call from B-channel number
- From GSM module number
- First incoming call from GSM

D:\Dokumenty\00-Release program   Save to file

**Note**

- Tracing can be activated only for one session at a time. The other sessions receive a BUSY message if requesting for tracing.

## Settings Menu

This menu displays basic configuration settings of the configuration tool. In this section you can choose a language and communication parameters.

---

## Communication Settings

---

The configuration tool can establish the gateway connection either locally via a serial line (RS232), or remotely via the TCP/IP – Telnet protocol, or via a modem. To set the type of connection, use the **Setting > Communication settings** section.

### Communication types

- **Serial communication**  
Program communication through the RS232 serial interface at a transmission rate of 57,600bps;
- **LAN communication**  
The configuration tool will try to establish the gateway connection via the TCP/IP-Telnet protocol. In the case of normal connection, you will be requested for the IP address, IP port, username and password of the remote gateway. To connect with a gateway from the **Gateway list**, the configuration tool will use saved connection parameters.
- **Modem**  
An internal analogue modem is used.
- **ISDN modem**  
Communication through an ISDN modem and PRI card of the PRI gateway.

After selecting the required connection type, click on **OK** to select the proffered type of connection.

---

## ISDN Modem

---

Here configure the connected ISDN modem. The modem must support the X.75 transmission protocol.

**Note**

- An HDLC chip is also located on the AUX board, enabling remote control over the ISDN PRI interfaces. This chipset is an optional part of system.

## Help Menu

The **Help** menu contains information about the configuration tool version and the firmware version compatible with this configuration tool.

## Button Bar

The button bar menu facilitates access to frequently used functions.

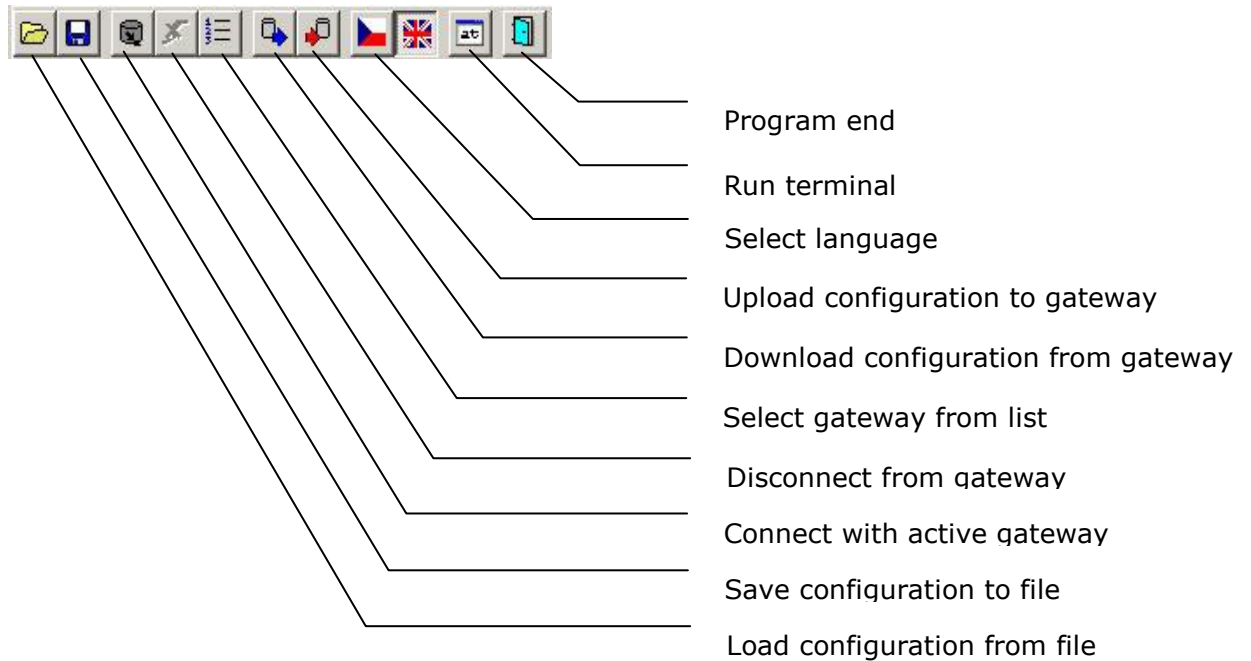

## Configuration Menu

There are two types of configuration parameters in the gateways:

- The on-line configuration parameters, which are available only if the gateway is connected. The items included in this section are described in the **Main menu > Gateway control menu** section. The items in this section are indicated by variable icons informing you of the available configuration possibilities:

 Date/time = gateway disconnected, no possibility to change on-line parameters;

 Date/time = gateway connected, you can change on-line parameters.

- The off-line configuration parameters can be set and saved into the cfg file. These parameters are described below.
- Reset commands are items responsible for the reboot of the connected gateway, or reboot with factory setting restoration.

## Off-Line Configuration

As already mentioned, the program includes the **Topics** and **Alphabetical glossary** folder menus. These menus contain identical items (as shown in the figures below) and the user may decide which to choose for easier orientation. You can set the ISDN GSM gateway parameters in these menus.

### Topics and Alphabetical Glossary

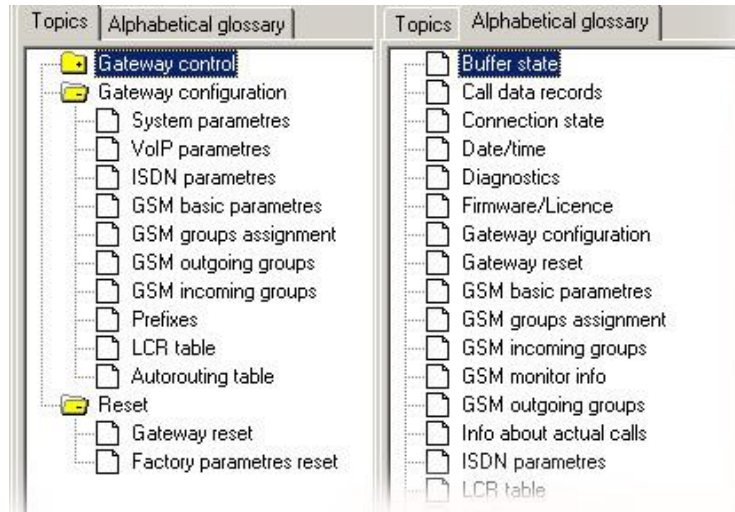

Topics Glossary

Alphabetical Glossary

### Status Line

The configuration status line provides basic information on the gateway connected:

2N HQ : [COM2] Connected				2N BlueTower M112-0804640041, Limit : limited, Protocols : DSS1 SIP TUN , Networks : All, CPU112, SW : 02.52/02.30.01rc5			
Currently connected gateway Used COM port number		Connected gateway type Serial number of basic CPU		Information about active licence		Information about basic CPU type and used bootware / firmware version	

## Configuration

All configuration windows contain the following buttons for you to load / save configuration from / to the connected gateway or configuration file:

- **Save to gate**  
Upload all parameters of the selected configuration window to the gateway.
- **Load from gate**  
Download all parameters of the selected configuration window from the gateway.

- **Default**  
Load default values of this configuration window from the default configuration file.
- **Save to file**  
Save all parameters of the selected window to the configuration file.

## System Parameters

This window allows you to set the IP parameters of the basic CPU, type of signalling and other basic configuration parameters.

- **IP address**  
Basic CPU IP address.
- **Subnet mask**  
Basic CPU and VoIP card IP mask.
- **IP router**  
IP address of the network gateway to be used by the basic CPU and VoIP card.
- **Init sequence for modem**  
An AT command sent by the gateway via COM2 upon detecting a connected analogue or BRI ISDN modem. This parameter must be in the format of the AT command that is compatible with the connected equipment.
- **Saving call data (CDR)**  
A way of saving the Call Data Records into the basic CPU internal memory. With this parameter you can set which CDR types will be saved.
  - None – no record will be saved.
  - Successful outgoing – only successfully connected outgoing calls will be saved.

- All successful – all successfully connected calls will be saved.
  - All outgoing – all outgoing (including unconnected or rejected) calls will be saved.
  - All incoming – all incoming calls will be saved.
  - All – all types of calls will be saved.
- **PIN**

The PIN code that the gateway will use for SIM cards with PIN protection. All the SIM cards inserted in the gateway must have the same PIN code if the PIN protection is active. This parameter has no influence upon remote SIM cards used by the 2N<sup>®</sup> SIM Star system.
  - **Gateway ID**

The gateway identification number to be added to every CDR line. With this number you can more easily detect on which gateway the CDR were generated (in case you are collecting CDR from more than one gateway).
  - **General selection of SIM cards**

Selection of the SIM card holder to be used by the gateway. This parameter has no influence on the gateways connected to the 2N<sup>®</sup> SIM Star system.

    - According to GSM groups – the SIM card is selected according to the settings of the **Outgoing GSM group** to which the wireless module is assigned.
    - SIM card in slot # - hardware selection of the SIM card holder position. This setting overrides the **Outgoing GSM group** setting!
  - **Number for remote control (PRI 1, PRI 2)**

The remote control number for a date call via the B-channel of the ISDN PRI 1 or PRI 2 interfaces (this feature is optional, for details refer to Subs. 2.1 – PRI Board).
  - **Automatic log-out of GSM modules**

This function is used for automatic log-out of wireless modules from the wireless network in a selected time interval. If the logged-in modules are occupied by a call, the logged-out modules log in again automatically. If the traffic drops, the modules log out again from the network at random intervals.

    - Enable automatic log-out – enable/disable the feature.
    - Log-out hour – set the time interval for the wireless modules to start logging-out randomly from the wireless network.
    - Log-in hour – se the time interval for the wireless modules to start logging-in back to the wireless network.
    - Min. logged-in modules – set the minimum count of wireless modules that remain logged-in.
  - **Automatically move to summer/winter time**

An automatic change of the internal clock according to the local DST (Daylight Saving Time) conditions.
  - **Configure gateway as (use protocol)**

Use this parameter to switch the signalling protocol. The type of the used signalling protocol depends on the available fixed interface card (VoIP-SIP, or ISDN PRI).

    - ISDN-DSS1 – use this type of protocol when the connected gateway contains a 1PRI or 2PRI board.



- VoIP-SIP – use this type of protocol when the connected gateway contains a VoIP card.
- Enable FW upgrade through Ethernet  
Use this parameter to activate/deactivate upgrading of the basic CPU and VoIP card firmware over the TCP/IP connection.
  - Port – the IP port used for remote firmware upgrade. The default value is 2222. Please do not use the standard IP port values, which are reserved for other well-known TCP/IP services.

Examples of common services and assigned IP ports:

Service	IP port number
http	80
ftp	20,21
Telnet	23
SSH	22
SMTP	25,161,162,366
NTP	123
DNS	53
BOOTP	67,68
TFTP	69
POP	109,110
SFTP	115
IMAP	143,220
LDAP	389
HTTPS	443

 This is for orientation only. For a complete list refer to the Well-known ports on the Internet.

## VoIP Parameters

This window allows you to set all parameters related to the VoIP interface.



### Tip

- You have to restart the VoIP card upon any VoIP setting change.

**VoIP parameters**

<p>Mode/protocol (Set in 'ISDN parameters')</p> <p>Day of deleting statistics : <input type="text" value="1"/> ( 0=off)</p>	<p>SIP registration :</p> <p>Registration expires : <input type="text" value="600"/> [s]</p> <p>Reattempt registration : <input type="text" value="10"/> [s]</p> <p>Registration domain (realm): <input type="text"/></p> <p>Name : <input type="text"/></p> <p>Username : <input type="text"/></p> <p>Password : <input type="text"/></p> <p><input type="checkbox"/> Replace CLIP from GSM by registration name</p>																												
<p>SIP protocol settings :</p> <p><input type="checkbox"/> Send 180 Ringing instead of 183 Session progress</p> <p><input type="checkbox"/> Send 200 OK instead of 180/183</p> <p><input type="checkbox"/> Send 200 + Bye</p>	<p>Voice parameters :</p> <p>First RTP port : <input type="text" value="8000"/> (1st RTP port must be higher than 1024 and 2nd port must be higher or equal by 10 than 1st port )</p> <p>Last RTP port : <input type="text" value="8998"/></p>																												
<p>Codecs priority :</p> <p>Priority 1 : <input type="text" value="G-729 (18)"/></p> <p>Priority 2 : <input type="text" value="G-711a (8)"/></p> <p>Priority 3 : <input type="text" value="G-711u (0)"/></p> <p>Priority 4 : <input type="text" value="G-723 (4)"/></p>	<p>Codecs settings :</p> <table border="1" style="width: 100%; border-collapse: collapse;"> <thead> <tr> <th></th> <th>Number of blocks :</th> <th>VAD</th> </tr> </thead> <tbody> <tr> <td>G711</td> <td><input type="text" value="4"/></td> <td><input type="checkbox"/></td> </tr> <tr> <td>G723</td> <td><input type="text" value="1"/></td> <td><input type="checkbox"/></td> </tr> <tr> <td>G729</td> <td><input type="text" value="2"/></td> <td><input type="checkbox"/></td> </tr> </tbody> </table> <p>G723 bitrate : <input type="text" value="6.3 kbps"/></p>		Number of blocks :	VAD	G711	<input type="text" value="4"/>	<input type="checkbox"/>	G723	<input type="text" value="1"/>	<input type="checkbox"/>	G729	<input type="text" value="2"/>	<input type="checkbox"/>																
	Number of blocks :	VAD																											
G711	<input type="text" value="4"/>	<input type="checkbox"/>																											
G723	<input type="text" value="1"/>	<input type="checkbox"/>																											
G729	<input type="text" value="2"/>	<input type="checkbox"/>																											
<p>IP addresses :</p> <table border="1" style="width: 100%; border-collapse: collapse;"> <tr> <td>SIP proxy ( IP-&gt;GSM ) :</td> <td><input type="text" value="0.0.0.0"/></td> <td><input checked="" type="checkbox"/> Use default port</td> <td><input type="text" value="5060"/></td> </tr> <tr> <td>SIP proxy ( GSM-&gt; IP)</td> <td><input type="text" value="0.0.0.0"/></td> <td><input checked="" type="checkbox"/> Use default port</td> <td><input type="text" value="5060"/></td> </tr> <tr> <td>SIP registration :</td> <td><input type="text" value="0.0.0.0"/></td> <td><input checked="" type="checkbox"/> Use default port</td> <td><input type="text" value="5060"/></td> </tr> <tr> <td>NAT firewall :</td> <td><input type="text" value="0.0.0.0"/></td> <td></td> <td></td> </tr> <tr> <td>VoIP card / MGCP gateway :</td> <td><input type="text" value="0.0.0.0"/></td> <td></td> <td></td> </tr> <tr> <td>STUN server :</td> <td><input type="text" value="0.0.0.0"/></td> <td><input checked="" type="checkbox"/> Use default port</td> <td><input type="text" value="3478"/></td> </tr> <tr> <td>Next STUN server request : (60 - 6553s)</td> <td><input type="text" value="600"/> [s]</td> <td></td> <td></td> </tr> </table>		SIP proxy ( IP->GSM ) :	<input type="text" value="0.0.0.0"/>	<input checked="" type="checkbox"/> Use default port	<input type="text" value="5060"/>	SIP proxy ( GSM-> IP)	<input type="text" value="0.0.0.0"/>	<input checked="" type="checkbox"/> Use default port	<input type="text" value="5060"/>	SIP registration :	<input type="text" value="0.0.0.0"/>	<input checked="" type="checkbox"/> Use default port	<input type="text" value="5060"/>	NAT firewall :	<input type="text" value="0.0.0.0"/>			VoIP card / MGCP gateway :	<input type="text" value="0.0.0.0"/>			STUN server :	<input type="text" value="0.0.0.0"/>	<input checked="" type="checkbox"/> Use default port	<input type="text" value="3478"/>	Next STUN server request : (60 - 6553s)	<input type="text" value="600"/> [s]		
SIP proxy ( IP->GSM ) :	<input type="text" value="0.0.0.0"/>	<input checked="" type="checkbox"/> Use default port	<input type="text" value="5060"/>																										
SIP proxy ( GSM-> IP)	<input type="text" value="0.0.0.0"/>	<input checked="" type="checkbox"/> Use default port	<input type="text" value="5060"/>																										
SIP registration :	<input type="text" value="0.0.0.0"/>	<input checked="" type="checkbox"/> Use default port	<input type="text" value="5060"/>																										
NAT firewall :	<input type="text" value="0.0.0.0"/>																												
VoIP card / MGCP gateway :	<input type="text" value="0.0.0.0"/>																												
STUN server :	<input type="text" value="0.0.0.0"/>	<input checked="" type="checkbox"/> Use default port	<input type="text" value="3478"/>																										
Next STUN server request : (60 - 6553s)	<input type="text" value="600"/> [s]																												
<p> <input type="button" value="Save to gateway"/> <input type="button" value="Load from gateway"/> <input type="button" value="Default"/> <input type="button" value="Save to file"/> </p>																													

- **Day of deleting statistics**  
Set a day in the month when the VoIP card call statistics will be deleted automatically.
- **SIP protocol settings**  
Use the parameters to modify the standard call SIP signalling process in the case of VoIP-to-GSM/UMTS call.
  - Send 180 ... – the gateway will send message 180 instead of 183.
  - Send 200 OK ... – the gateway will send message 200-OK instead of the above messages 180/183.
  - Send 200+ Bye – the gateway will add message 200 + Bye before a rejected call.
- **Voice parameters**  
Use these parameters to define the range of the IP ports for RTP streams. The

RTP protocol is used for voice calls. Each voice call needs two RTP streams (one for each way). The first RTP port value must be higher than 1024.

- **Codec priority**

Select a voice codec for audio calls. If your SIP proxy does not offer one matching audio codec at least, the call will be rejected!

- **IP addresses**

Here set the IP address and IP port for the SIP proxy, VoIP card, NAT and STUN servers.

- SIP proxy – IP address and IP port for incoming and outgoing calls. When you set **SIP proxy IP>GSM** to 0.0.0.0, the gateway will receive incoming calls from any SIP proxy!
- SIP registration – IP address of the registration SIP proxy server.
- NAT firewall – IP address of the used NAT (Network Address Translation) firewall router.
- VoIP card / MGCP gateway – required IP address of the VoIP card of the connected gateway.
- STUN server – public IP address of the STUN (Simple Traversal of UDP through NAT) server. The STUN server will give the public IP address of your IP router. This public IP address will be used in the VoIP cards. The STUN server is required in case your public IP connection has no fixed IP address.
- Next STUN server request – time period between two requests for public IP information. The gateway will also send request after every system restart.



#### Note

- The default IP port for SIP signalling is 5060. The RTP range is 8000-8998. The STUN port is 3478.
- In case the gateway is behind the NAT, you have to forward NAT routing to the appropriate port. Integrated firewalls can also have influence on VoIP calls!



#### Tip

- In case you have problem with calls (one side audio, no connection, etc.), check the configuration of all active components (routers) on the VoIP call route. For easier troubleshooting, we recommend that a network protocol analyser should be used (e.g. Wireshark – [www.wireshark.org](http://www.wireshark.org)).

- **SIP registration**

Here set all parameters for registration with the registration SIP proxy.

- Registration expires – registration validity term.
- Re-attempt registration – time interval for repeated registration request in case of registration failure.
- Registration domain (Realm) – required registration domain.
- Name – registration name.
- Username / Password – registration username and password. These parameters are write-only for security reasons.

- Replace CLIP ... – use this parameter to replace the GSM / UMTS network CLIP with the registration settings above.

- **Codec settings**

Additional settings for the voice codec used. For the default settings see the table below.

Codec	Number of blocks	VAD (Voice Activity Detection)
G.711	4	Deactivated
G.729	2	Deactivated
G.723	2	Deactivated

G. 723 bitrate is 6.3 kbps



### Caution

- Using low rate codecs may deteriorate voice quality!
- You have to have a wide-band TCP/IP connection for using a high rate codec!
- You can use an Internet VoIP bandwidth calculator to calculate the actually required bandwidth (e.g. [www.bandcalc.com](http://www.bandcalc.com)).

---

## ISDN Parameters

---

This window allows you to set all parameters related to the VoIP interface.



### Note

- A ISDN PRI line mode change will cause an automatic change of the gateway.

**ISDN parameters**

---

**ISDN**

**PRI 1**

ISDN PRI port type : TE Synchronization : Slave

Channel number select : Upwards Preferred channel : 0  
(0 = no preferred)

**PRI 2**

ISDN PRI port type : N7 Synchronization : Master  
(Valid only if PRI 2 exists)

Channel number select : Upwards Preferred channel : 0  
(0 = no preferred)

TEI address : 0 Assignment of GSM-channel : Locked

CRC  
(Valid for both PRI ports if they are presented)

Progress indicator value :

Message SETUP\_ACKNOWLEDGE : 8 (0 = off) Message SETUP\_PROGRESS : 0 (0 = off)

Message SETUP\_PROCEEDING : 8 (0 = off) Message SETUP\_ALERTING : 8 (0 = off)

<p><b>Error ISDN/VoIP causes :</b></p> <p>Lack of digits in OVERLAP mode: <span style="border: 1px solid gray; padding: 2px;">102</span></p> <p>Restricted number prefix : <span style="border: 1px solid gray; padding: 2px;">21</span></p> <p>Selected module/GSM group is not ready : <span style="border: 1px solid gray; padding: 2px;">41</span></p> <p>No module/GSM group is ready : <span style="border: 1px solid gray; padding: 2px;">42</span></p>	<p><b>Cause transfer :</b></p> <div style="border: 1px solid gray; height: 80px; width: 100%;"></div> <p style="text-align: right;"> <span style="border: 1px solid gray; padding: 2px 10px;">Add</span>  <span style="border: 1px solid gray; padding: 2px 10px;">Remove</span>  <span style="border: 1px solid gray; padding: 2px 10px;">Remove all</span> </p>
--	---

**PRI functions:**

Allow delete of statistics on PRI every month  Receive dial number from Subaddress

1 . day in month delete  Hungarian dialtone after 2 digits

Digits count in SETUP (en-block) : 20  Don't send ConnectAck on TE

<p><b>Tone signalling :</b></p> <p>Dialtone to GSM : <span style="border: 1px solid gray; padding: 2px;">None</span></p> <p>Ring tone : <span style="border: 1px solid gray; padding: 2px;">None</span></p> <p>Generate busy tone to PRI1 : <span style="border: 1px solid gray; padding: 2px;">None</span></p> <p>Generate busy tone to PRI2 : <span style="border: 1px solid gray; padding: 2px;">None</span></p>	<p><b>Numbering plan settings :</b></p> <p>CDN : <span style="border: 1px solid gray; padding: 2px;">0</span></p> <p>CGN : <span style="border: 1px solid gray; padding: 2px;">0</span></p>
---	---

■ **ISDN PRI 1, PRI 2**

Set the main configuration of the PRI 1 (PRI 2) ISDN interfaces located on the PRI card:

- ISDN PRI port type – here define the PRI 1 (2) ISDN port type.

- Synchronisation – define if the gateway will send the synchronisation clock (MASTER) or receive the synchronisation clock from the connected line (SLAVE).
- Channel number select – define the way of occupation of B-channels on a selected ISDN PRI interface. With the UPWARDS selection, the gateway will occupy the B-channels upwardly (from the selected B-channel number to the B-channel 32). With the DOWNWARD selection, the gateway will occupy the B-channels in the descending order (from the selected B-channel number to B-channel 1).

**Note**

- The PRI 1 port is always set as internal – the LCR function is activated. The PRI 2 port is always set as external – all calls from PRI 2 are rerouted to PRI 1. The PRI 2 port has a mode opposite to that of the PRI 1 port. For additional information refer to Subs. 2.4 ISDN PRI Connection.
- In the case of ISDN port mode change, change the selection of the ISDN PRI card jumpers, see Subs. 2.1 PRI Board.

■ **TEI address**

The Terminal Equipment Identification number for the ISDN PRI line connected. The TEI must be identical for both devices on one ISDN PRI line. The default value is 0.

■ **CRC**

Enable/disable receiving CRC on Layer 1 on the ISDN PRI interfaces (in both modes the gateway sends the CRC).

■ **Assignment of GSM channel**

Define the way of using GSM / UMTS engines as assigned in the **Outgoing GSM group** for outgoing calls:

- Cyclical – the gateway routes outgoing calls according to the LCR settings to the defined outgoing GSM group. The wireless engines assigned to the used outgoing group are used sequentially in a rotating way (1. > 2. > 3. > 4. > 1. > 2. > ...).
- Locked – the gateway ignores the LCR table and uses the wireless engine according to the used B-channel.
- According to credit - the gateway routes all outgoing calls according to the LCR settings to the **defined outgoing GSM group**. The wireless engines assigned to the used outgoing group are used by the lowest number of called minutes (according to the statistic records of the selected outgoing GSM group).

■ **Progress indicator value**

Define which progress element value will be sent in the selected ISDN messages. The correct setting of these parameters depends on the current settings of the opposite device (PBX / Router). This parameter is primarily designed for opening the B-channel before call connection – transferring call state tones (e.g. ringing tone) from GSM / UMTS networks. The following table contains common values of progress elements.

Value	Meaning	Event
-------	---------	-------

0	No progress element sending	B-channel closed
1	Call is not end-to-end ISDN or may be in-band information	B-channel opened
2	Destination call address is non-ISDN	B-channel opened
3	Origination call address is non-ISDN	B-channel opened
4	Call has returned to the ISDN	B-channel closed
8	In-band treatment has been applied	B-channel opened
10	Delay in response at the call interface	B-channel closed



### Caution

- Wrong settings of these parameters may cause malfunction of the ISDN PRI line (call connection)!

#### ■ Error ISDN / VoIP causes

Define the number of the ISDN release cause whenever an incoming call from an ISDN line is rejected. The parameter is designed for the ISDN release cause values. With a VoIP card (VoIP-SIP connection), use the conversion table below.

- Lack of digits in OVERLAP mode – rejects the incoming call that does not meet the required number length (see the **GSM basic parameter** for right settings). The default value is 102.
- Restricted number prefix – rejects the incoming call whose prefix does not match any of the prefixes defined in the **Prefixes**. The default value is 21.
- Selected module / GSM group is not ready – rejects the incoming call because no free wireless engine has been found in the selected (according to the LCR table settings) GSM outgoing group. The default value is 41.
- Selected module / GSM groups are not ready – rejects the incoming call because no free module has been found in all the used (according to the configuration) GSM outgoing groups. The default value is 42.



### Tip

- Call rejection in the case of call connection request (SETUP message) from the PBX / Router / SIP proxy with a defined cause enables call rerouting via another ISDN PRI line / gateway. This feature is used for router settings.

#### Conversion table:

ISDN cause value	Description	SIP code	Description
1	Unallocated number	410	Gone

---

<b>3</b>	No route to destination	404	Not found
<b>6</b>	Channel unacceptable	503	Service unavailable
<b>16</b>	Normal call clearing	BYE	
<b>17</b>	User busy	486	Busy here
<b>18</b>	No user responding	480	Temporarily unavailable
<b>19</b>	No answer from user	480	Temporarily unavailable
<b>21</b>	Call rejected	603	Decline
<b>22</b>	Number changed	410	Gone
<b>27</b>	Destination out of order	404	Not found
<b>28</b>	Address incomplete	484	Address incomplete
<b>29</b>	Facility rejected	501	Not implemented
<b>31</b>	Normal, unspecified	BYE	
<b>34</b>	No circuit available	503	Service unavailable
<b>38</b>	Network out of order	503	Service unavailable
<b>41</b>	Temporary failure	503	Service unavailable
<b>42</b>	Switching equipment congestion	503	Service unavailable
<b>44</b>	Requested facility not subscribed	503	Service unavailable
<b>47</b>	Resource unavailable	503	Service unavailable
<b>50</b>	Requested facility not subscribed	503	Service unavailable
<b>55</b>	Incoming class barred within CVG	603	Decline
<b>57</b>	Bearer capability not authorised	501	Not implemented
<b>58</b>	Bearer cap, unavailable at present	501	Not implemented
<b>63</b>	Service or option unavailable	503	Service unavailable
<b>65</b>	Bearer cap, not implemented	501	Not implemented
<b>79</b>	Service or option not implemented	501	Not implemented
<b>87</b>	User not member of CVG	603	Decline
<b>88</b>	Incompatible destination	400	Bad request
<b>98</b>	Invalid message	400	Bad request
<b>102</b>	Recover on timer expiry	408	Request timeout
<b>XXX</b>	The other received CAU from netw.	500	Internal server error

---

- **Cause transfer**

A list of release causes that the gateway receives and then translates into a user-defined release cause sent to the ISDN PRI interface. Together with the above conversion table, this table also applies to VoIP-SIP calls.

- **Allow delete of statistics on PRI every month**

Enable deletion of call statistics over the PRI interfaces on a selected day of the month.

- **Digits count in SETUP**

Set the number of digits to be sent in the SETUP message as ENBLOCK. The



others digits will be sent in the OVERLAP dial mode.

Example of use:

Called party number: 6012345678, digits count in SETUP = 7

Outgoing signalling messages:

```
SETUP (contains 6012345)
INFO (6)
INFO (7)
INFO (8)
```

- **Receive dial number from Subaddress**  
With this parameter activated, the gateway uses the digits in the **Subaddress** field instead of the **Called party number** for outgoing dialling.
- **Hungarian dial tone after two digits**  
A specific feature designed for the Hungarian national dialling plan. The gateway activates a specific dialtone for second dialling after receiving two digits.
- **Do not send CONNECT\_ACK on TE**  
When the ISDN PRI is in the TE mode, the gateway will not send the CONNECT\_ACK message.
- **Tone signalling**  
National settings of dialling and ringing tones. You can enable the busy tone in the case of call reject.
- **Numbering plan settings**  
Use these parameters to set the right numbering plan for the Called and Calling party numbers according to DSS1 signalling protocol.

---

## GSM Basic Settings

---

This window allows you to set basic parameters related to the wireless interfaces.

GSM basic parameters

Number of digits dialed from ISDN/VoIP Min. numbers from ISDN/VoIP : 9 Max. numbers from ISDN/VoIP : 9 Wait for next digit [s] : 3		Holiday list : <input type="text"/> <input type="button" value="Add"/> <input type="button" value="Remove"/> <input type="button" value="Remove all"/>	
Call delay [s] : 2		DTMF numbers : Delay [ms] : 1	
Voice parameters of Ericsson modules : Transmission vol. : -5 -2.5 0 +2.5 +5 Reception vol. : -5 -2.5 0 +2.5 +5		Voice parameters of Siemens GSM modules : Transmission vol. : -5 -2.5 0 +2.5 +5 Reception vol. : -5 -2.5 0 +2.5 +5 <input type="checkbox"/> Siemens tone	
Voice parameters of Wavecom modules : Echo cancelling : Echo 1,1,0,3,10,7 Transmission vol. : -6 -4 -2 0 +2 +4 +6 Reception vol. : -6 -4 -2 0 +2 +4 +6		Text of SMS at no answer : <input type="text"/> SIM card number : IMSI <input type="checkbox"/> Disable CLIP from GSM to ISDN	
Settings for 3G Motorola phones : Delay between hang up and dial (seconds/10) : 1 Duration of keystroke (seconds/10) : 0 Timeout between two dialed digits (seconds/10) : 1			
Tone signalling: Dialtone to GSM : European Ring tone : European Generate busy tone to GSM : None			
Sierra wireless modules settings : Transmission vol. : -5 -2.5 0 +2.5 +5 Reception vol. : -5 -2.5 0 +2.5 +5 Use networks : GSM and 3G Searching priority : Automatically <input type="checkbox"/> Init module after call Received SMS save to : GSM module			

### ■ Number of digits dialled from ISDN

Define the Called party number limits for outgoing calls to wireless networks:

- Min numbers from ISDN – set the minimum count of digits to be dialled into a wireless network.
- Max numbers from ISDN – set the maximum number of digits to be dialled into a wireless network.
- Wait for next digit – set a timeout in seconds for the gateway to wait for next dialled digit (OVERLAP dial mode). After the timeout, the dialled number will be automatically sent to the wireless network.

### ■ Call delay

Define the minimum timeout between the end of a call and the beginning of another outgoing call for one wireless engine. The default value is two seconds. Unless absolutely necessary, do not change the default value to avoid system instability.

### ■ Holiday list

Define the days on which the gateway will apply the weekend mode LCR.

### ■ DTMF numbers

Set sensitivity of the DTMF receivers on the GSM / UMTS boards. The step is a 10-millisecond value added to the default value of 20ms. The total time is the minimum delay between two received DTMF symbols.

- **Voice parameter settings**

Set the receive/transmit volume according to the used wireless engine manufacturer:



### Caution

- A change of the default values may exercise negative effects upon other transmission parameters such as echo!
  - Siemens tone – here activate a specific call connection tone for Siemens TC35(i) GSM modules.
  - Init module after call – enable re-initialisation of the MC8755V module in the case of an outgoing call end.
  - Use networks – define the wireless network type to be used.
  - Searching priority – set the wireless network searching priority.
  - Echo cancelling – enable/disable the echo cancellation mode.
- **SIM card number**  
The SIM card serial number (IMSI, SCID) for Cinterion (Siemens) wireless engines. This serial number is used for the CDR and diagnostics.
- **Disable CLIP from GSM to ISDN**  
Disable CLIP transfer from wireless networks to the ISDN / VoIP interfaces.
- **Text of SMS at no answer**  
Type the text for automatic SMS messages sent in the case of unanswered outgoing calls (see the **GSM Outgoing Groups** below). If string %n is used, the gateway replaces it with the Calling party number.
- **Tone signalling**  
National settings of dialling and ringing tones. You can enable the busy tone in the case of call reject.

## GSM Group Assignment

Below is a table for assignment of wireless modules to Outgoing (PRI/VoIP>GSM/UMTS) and Incoming (GSM/UMTS>PRI/VoIP) GSM groups. The wireless module numbers are counted from the left (the power supply unit side) next to PRI boards 0 and 1. The GSM module is in the first GSM/UMTS board position. The maximum number of wireless engines matches the connected gateway type.

GSM groups assignment		
Groups assignment :		
Module :	Outgoing :	Incoming :
0. module	1. Group	1. Group
1. module	1. Group	1. Group
2. module	1. Group	1. Group
3. module	1. Group	1. Group
4. module	1. Group	1. Group

Each wireless engine must be assigned to one outgoing group and one incoming group. All incoming and outgoing call routing rules are used for outgoing and incoming groups of wireless engines.

## GSM Outgoing Groups

This window allows you to set parameters related to outgoing calls to wireless networks and the SIM card using time.

GSM outgoing groups

1 GSM group
2 GSM group
3 GSM group
4 GSM group
5 GSM group
6 GSM group
7 GSM group
8 GSM group

Mode of switching SIM card : SIM 1 ▾

Last searched SIM : (8 - all SIM will be searched) SIM 8 ▾

Disconnect call :
 

- SIM limit exceeded
- Switch to another SIM
- No ALERTING before CONNECT

Delay for CONNECT [s] : (0 = off) 0 ▾  
 Default delay for "SMS at no answer" [s] : (0 = off) 0 ▾  
 Delay for ALERTING [s] : (0 = off) 5 ▾

Day of deleting stats in group : 1 ▾

SIM settings : SIM 5-8 is SIM 4 ▾

Disable tone detector  
 Generate virtual ring tone

Send CLIP from ISDN to GSM :  
Attention! Must be supported by your GSM / 3G operator. In other case outgoing calls to GSM / 3G can be rejected!  
 Transfer CLIP to GSM    Separating char :

'Minute' parameter : Count of minutes ▾

Call length counting : Seconds ▾

SIM 1
SIM 2
SIM 3
SIM 4 - 8

Roaming enabled for network :   
 CLIR : Factory ▾  
 Max. number of called minutes : (0 = off) 0  
 SMS messages number : 0  
 Day of restore call limit and delete statistics : 1 ▾  
(0=off,32=every day)  
 First count : 1 ▾  
 Next count : 1 ▾  
 Day limit of called minutes : (0 = off) 0 ▾

Time to switch to another SIM

From : 00:00 To : 24:00

Enable on weekends  
 Use whole weekend  
 Use the above set time

Use 2nd interval

From : 00:00 To : 24:00

Enable on weekends  
 Use whole weekend  
 Use the above set time

- **Mode of switching SIM card**  
Define how the SIM cards should be used in the selected GSM group:

- SIM # - the SIM cards in position # will only be used in the selected GSM group. In this case, the **Maximum called minutes** and **Disconnect call** parameters are disabled.
- By time - the SIM card will be switched according to the **Time of use** parameter and call timer limitations.
- Random - the SIM card will be switched randomly at defined time intervals and according to call timer limitations.
- By time then SIM card 1 - the SIM card will be switched according to the **Time of use** parameter and call timer limitations. When all SIM cards on a selected wireless engine are discharged, the system will switch the wireless engine back to the SIM card in position 1.
- Random - the SIM card will be switched randomly at defined time intervals and according to call timer limitations. When all SIM cards on a selected wireless engine are discharged, system will switch the wireless engine back to the SIM card in position 1.



### Note

- For SIM card (SIM holder) placement on the GSM / UMTS board refer to Subs. 2.1 - GSM / UMTS Board.

- **Last searched SIM**

Define the number of SIM holder positions to be checked for SIM by the gateway after the GSM / UMTS board start/restart. The SIM card holders that were not tested have the (undef) status in the diagnostics window of the configuration tool.

- **Disconnect call**

Set the rules for automatic disconnection of outgoing calls to a wireless network:

- SIM limit exceeded - automatic call disconnection when the active SIM card call limit is exceeded.
- Switch to another SIM - automatic call disconnection when the active SIM card time of use is exhausted.
- No ALERTING before CONNECT - automatic call disconnection when the gateway receives the call connect message without alerting.

- **Day of deleting stats in group**

Enable deletion of call statistics over a selected GSM group on a selected day of each month.

- **SIM settings**

Select which settings will be used for the SIM cards in positions 5 - 8:

- SIM 5-8 is SIM 4 - all settings for the SIM cards in positions 5 - 8 will be the same as those for the SIM card in position 4.
- SIM 5-8 is SIM 1-4 - all settings for the SIM card in position 5 will be the same as those for the SIM card in position 1. The SIM card in position 6 will use settings of the SIM card in position 2, SIM 3 = SIM 7 and SIM 4 = SIM 8.

- **Disable tone detection**

Deactivate the alerting tone detectors on the GSM / UMTS boards. Used for

the GSM / UMTS networks that send call statuses through the signalling channel.

- **Generate virtual ring tone**

Use this parameter to activate an internal ring tone generator for cases when ISDN B-channel (RTP stream on VoIP) is opened and the wireless network ring tones should be restricted.

- **Delay for CONNECT**

Define the delay for sending the Connect message to the ISDN PRI interface (OK in case of VoIP) after the gateway receives Connect from the wireless network.

- **Delay for ALERTING**

Define the delay for sending the Alerting message to the ISDN PRI interface (Ringing in case of VoIP) after the gateway receives Alerting from the wireless network:

- 0 = no Alerting message will be forwarded.
- 1 = the Alerting message will be forwarded as soon as the gateway receives Alerting from the wireless network or ring tone detectors detect the alerting tone (if active).
- 2 = the Alerting message will be automatically sent after a predefined number of seconds after the call is dialled into wireless network.

- **Default delay for SMS at no answer**

Set the minimum time for a call in the alerting state for automatic sending of a defined SMS text in the case of unanswered outgoing call.



### Note

- For successful SMS sending, the Alerting message to the ISDN interface (ringing for VoIP) and the SETUP/INVITE message must contain the Called party number.

- **'Minute' parameter**

Set the mode for the **Max number of called minutes** parameter in the SIM card setting section:

- Count of minutes – the SIM card use is limited by the number of called minutes.
- Count of call – the SIM card use is limited by the number of outgoing calls.

- **Call length counting**

Set the outgoing call length counting accuracy (**First count**, **Next count** parameters):

- Seconds – the total call length is calculated in seconds.
- Minutes – the total call length is calculated in minutes.

- **Send CLIP from ISDN to GSM**

Enable CLIP forwarding from ISDN / VoIP to wireless networks using the ATD dial command.



### Caution

- This feature must be supported by your wireless network provider. Otherwise it may cause failure of outgoing calls to wireless network!

- **Roaming enabled for network**

Enable the SIM card to log in to roaming networks. To do so, add a whole or part of the MCC+MNC code (international identification code for wireless networks). Leave the field free if you want to keep the roaming access disabled for SIM cards. Examples of correct inputs:

Input	Note
<empty>	Roaming is restricted
2300	Roaming is restricted (minimum is five digits)
23002	Roaming is permitted for network with MCC+MNC code 23002
230XX	Roaming is permitted for network with MCC+MNC codes 23000 – 23099
XX001	Roaming is permitted for network with MCC+MNC codes 00001 – 99001
XXXXX	Roaming is permitted for any network



### Note

- Before activating the roaming support, please check the SIM card for correct setting of the GSM / UMTS priority network list.



### Caution

- Calls via roaming networks may cause additional call costs!

- **CLIR**

Use the parameter to enable/disable the CLIR and CLIP functions for outgoing calls via the SIM cards in selected positions:

- Default – CLIP and CLIR will be used according to the wireless network settings.
- Disable (CLIP – on) – CLIR is disabled and CLIP is temporarily enabled.
- Enable (CLIP – off) – CLIR is enabled and CLIP is temporarily disabled.



### Caution

- The CLIP and CLIR functions are wireless network services. In case your network disallows temporary activation of the CLIP / CLIR function, set the Default value.
- A wrong setting of this parameter may cause failure of outgoing calls!

- **Max number of called minutes**  
Set the maximum count of called minutes / calls via the SIM card in a selected position.
- **SMS message number**  
Set the maximum count of SMS messages sent via the SIM card in a selected position.
- **Day of restore call limit and delete statistics**  
Enable deletion of call statistics over a selected SIM card on a defined day of each month.
- **First count**  
Set the length of the first count. After this time, the gateway will use the **Next count** parameter for calculating the call length (1 to 250 seconds, or 1 to 250 minutes).
- **Next count**  
Set the length of the next counts (1 to 250 seconds, or 1 to 250 minutes).



### Note

- The **First count** and **Next count** parameters are used for calculating the real call length from the wireless provider's point of view.  
Example 1: Calls are charged second by second.  
Settings: Both parameters are set to 1. The **Call length counting** parameter is set to seconds.  
Example 2: Calls are charged for the first minute and then second by second.  
Settings: The **First count** parameter is set to 60, the **Next count** parameter to 1. The **Call length counting** parameter is set to seconds.

A proper setting of these parameters helps you keep a realistic record of the minutes spent and charged for each SIM card. These parameters are used for limit counters, call statistics, but not for the CDR.

- **Day limit of called minutes**  
Set the maximum count of called minutes over one SIM card in one day.
- **Time to switch to another SIM card**  
Set the using time for the SIM card in a selected position. This parameter is used in case the **Mode of switching SIM card** parameter is set to 'by time' or 'random'.
  - Enable on weekends – enable the SIM card also for weekends /Saturday,Sunday,Holidays/ (as a whole or according to week time limitations).



### Note

- The SIM card switching rules are designed for local SIM cards only. In case the gateway is connected to 2N<sup>®</sup> SIM Star, the rules are governed by the 2N<sup>®</sup> SIM Star Server unit (only for the GSM / UMTS boards supported by 2N<sup>®</sup> SIM Star).



## GSM Incoming Groups

This window allows you to set parameters related to incoming calls from wireless networks and the SIM card using time.

The screenshot shows the 'GSM incoming groups' configuration window. It features a tabbed interface with tabs for '1 GSM group', '2 GSM group', '3 GSM group', '4 GSM group', and 'Direct routing'. The 'Mode' dropdown is set to 'Accept incoming calls + voice message'. Below this, there is a note: '(Call number by %A, %G95..8 or none or answer and wait for DTMF)'. The configuration includes several input fields: 'Min. digits in DTMF' (3), 'Max. digits in DTMF' (3), 'Timeout while inputing DTMF digits [s]' (10), 'Day of deleting stats' (1), 'Prefix before DISA preselection' (261301), 'CLIP' (+), 'Looping of voice mess' (0), 'Time to keep CLIP in table [hours]' (0), and 'CDN recognition in clip (Separating char)' (empty). There are 'Add', 'Remove', and 'Remove all' buttons. At the bottom, there are two checked checkboxes: 'Add record only for unconnected call' and 'Delete record for connected answer'.

### ■ Mode

Define how the gateway should process incoming calls from wireless networks and route them to the ISDN or VoIP interface:

- Reject incoming calls – the gateway bars incoming calls from wireless networks (the calling party gets the busy tone).
- Ignore incoming calls – the gateway ignores incoming calls (the calling party gets the ringing tone).
- Receive incoming calls + voice message – all incoming calls are routed to PRI 1/VoIP. If the **Timeout...** parameter is greater than 0 seconds, the calling party hears the DISA message for DTMF dial-in.
- Receive incoming calls + dial tone - all incoming calls are routed to PRI 1/VoIP. If the **Timeout...** parameter is greater than 0 seconds, the calling party hears the defined dial tone for DTMF dial-in.
- After ring call back / refuse – the CallBack function is activated for all calling parties with the CLIP saved in the Auto routing table. Calls with unknown CLIPs are rejected.
- After ring call back / ignore - the CallBack function is activated for all calling parties with the CLIP saved in the Auto routing table. Calls with unknown CLIPs are ignored.

- Report to PC + voice message – an external routing software feature (see Subs. 3.6). In the case of received call, the calling party hears the DISA voice message for DTMF dial-in.
- Report to PC + dial tone - an external routing software feature (see Subs. 3.6). In the case of received call, the calling party hears the dial tone for DTMF dial-in.
- **Min digits in DTMF**  
Set the minimum count of DTMF digits for accepting the DTMF dial-in function.
- **Max digits in DTMF**  
Set the maximum count of digits to be DTMF-dialled for incoming calls. After the last (maximum) DTMF dialling, an ISDN/VoIP call is made automatically with the currently selected DTMF prefix.
- **Timeout while inputting DTMF digits**  
Set the waiting time in seconds for the next DTMF digit (the timeout is 20 seconds for the first DTMF digit). After this timeout, either the DTMF number received so far is dialled into PRI 1/VoIP or, if no DTMF digit is dialled, a number is dialled from the **List of called numbers**.
- **List of called numbers**  
A list of numbers to be dialled automatically sequentially (in the case of unavailability or busy) if no DTMF dialling (DISA) is made.
- **Prefix before DISA preselection**  
The prefix the gateway adds before the DTMF dial-in. For example: the received DTMF digits are 487 and this prefix is 6655. The gateway will send number 6655487 to the ISDN PRI interface.
- **CLIP**  
Here you can change the incoming CLIPs from wireless networks. The default format of the incoming CLIP is defined. To modify the format, use the table below:

#### Incoming CLIP = 420261301500

Parameter value	CLIP to VoIP/PRI 1	Note
Null	420261301500	No change in CLIP
+	+420261301500	Add + before CLIP beginning
00	00420261301500	Add 00 before CLIP beginning
--	0261301500	Remove two first digits from CLIP beginning
---99	99261301500	Remove first three digits and add 99 before CLIP beginning

- **Looping of voice message**  
Set the DISA voice message playing time in minutes.
- **Auto Clip Routing**  
Define the Auto Clip Routing feature. The gateway can automatically save information about all outgoing calls (time, calling party and called party numbers). In case the called party makes a CallBack to the gateway within a predefined time, the gateway will automatically connect it to the saved calling party. All records are stored in the RAM memory and are erased by every gateway restart.

- **Time to keep CLIP in table**  
Set the time for keeping information on an outgoing call in the case of Auto Clip Routing. 0 = Auto Clip Routing is switched off.
- **Add record only for unconnected call**  
Unconnected outgoing calls are only saved into the Auto Clip Routing table.
- **Delete record for connected answer**  
A record is deleted automatically in the case of a successful CallBack connection.
- **Day of deleting stats**  
Enable deletion of call statistics over a selected GSM group on a defined day of each month.
- **CDN recognition in CLIP**  
Set separation of characters in case your GSM / UMTS provider offers you the automatic dial-in service. With this feature, the incoming CLIP is divided into two parts: +420601222111#500. Number +420601222111 is the CLIP and number 500 is the requested called party number (CPN) of your PBX/SIP proxy extension.



### Caution

- The automatic dial-in function is the wireless provider's service. Before activating this function, please ask your provider for additional information.

- **Direct routing**  
With this table you can assign a unique called party number (extension) to each GSM / UMTS module.

---

## Prefixes

---

This window allows you to set the call prefixes related to the LCR table. The gateway can contain up to eight prefix and prefix replacing tables. An additional table is used for replacing prefixes in the case of PRI 1-to-PRI 2 calls.



### Caution

- If 2N<sup>®</sup> External Routing Machine (or any other external routing system) is used, the gateway does not use the internal LCR rules! These rules will only be applied in the case of external routing system error!

- **Table of replaced prefixes**  
A table of prefixes that are to be replaced (in outgoing calls from PRI 1/VoIP to GSM / UMTS) by another prefix (e.g. +420 replaced by 0). This prefix change is made before the matching prefix is found in the **Table of prefixes!**
- **Table of prefixes**  
A table of called prefixes from PRI 1/VoIP. Here you can set the length of the

called number (in the case of the ISDN OVERLAP dial mode). If you do not fill in the table, the gateway will use the **Default number of digits** parameter.

- **GSM network ID**

Define your numeric identification of the wireless network for which the prefix list # will be used.

- **Prefix change for call from PRI 1 to PRI 2**

A table of prefixes to be replaced in the case of PRI 1-to-PRI 2 outgoing calls.

## LCR Table

A table of outgoing Least Cost Routing (LCR) rules. Every outgoing call from the PRI 1/VoIP interface is routed to GSM / UMTS according to this table. For a call, the gateway checks the lines and if the called number prefix matches the prefix in the selected network list and the current time value is within time limitation limits, the call will be routed via the defined GSM group(s) or PRI 2 interface.

LCR table			
Network	Using time	Groups	Limit
2/23001	00:00/24:00	34	30
1/23002	00:00/24:00/w+	129	0

- **Network ID**

The used prefix list number / value of the GSM network ID from the selected prefix list.

- **Groups**

Used destinations of outgoing GSM groups for outgoing calls if an LCR line is used. Other GSM groups (PRI 2) will be used in case the selected GSM group is unavailable for a new outgoing call – the call will be rerouted to the next GSM group according to the LCR line settings. In case that there is no other GSM group or PRI 2 set, the call will be rejected.

- **Time limitation if use**

An LCR line validity limitation.

- Enable on weekends – enable the LCR line also for weekends /Saturday,Sunday,Holidays/ (as a whole or according to week time limitations).
- Max length of call – the maximum length of the active outgoing call. 0 = unlimited call length.

## Auto Routing Table

A table including CLIP routing and CallBack functions:

Autorouting table			
GSM number (CLIP)	Dial	Limit	Autorouting type
+420601111222	2500		Autodial
+420602333444		30	Autocallback

The dialog box titled "Add/edit autorouting numbers" contains the following fields and options:

- GSM number (CLIP): [Text input field]
- Dial: [Text input field]
- Limit:  Limit (0 = off) [Dropdown menu with '0' selected]
- Autodial:  Autodial
- Autocallback:  Autocallback
- Buttons: OK, Cancel

- **GSM number (CLIP)**  
CLIP of the incoming calling party that should use the CLIP routing or CallBack functions.
- **Dial**  
Number of the internal extension / SIP line in the case of activated CLIP routing.
- **Limit**  
The maximum length of an active outgoing call. 0 = unlimited call length.
- **Autodial**  
Use the parameter to activate the CLIP routing function for a selected CLIP.
- **Auto Callback**  
Use the parameter to activate the CallBack function for a selected CLIP.

## Restart

This section is used for on-line restarting of the gateway or restart with factory setting restoring.

---

## Reset

---

Resets the connected gateway and initialises all boards (the gateway communication is not discontinued but all current calls and SMS to be sent are terminated!).



### Note

- Restart of the gateway will cause disconnection of all proceeding calls.

---

## Factory Reset

---

Resets the connected gateway, selecting the factory settings for the gateway.



### Caution

- Using this function you erase all settings except for the IP setting and access username and password!
- Restart of the gateway will cause disconnection of all proceeding calls!

## 3.5 Enhanced CPU Configuration

The enhanced version of the CPU board (eCPU) is located on the CPU card. For the complete hardware description see Subs. 2.1 – Enhanced CPU Board. The enhanced CPU board supports all basic CPU features plus several new features:

- A comfortable graphic web interface for easy remote control and gateway configuration;
- Support of the 2N<sup>®</sup> SIM Star system;
- Support of the SMTP and POP3 protocols for sending/receiving SMS;
- CDR downloader (an SD card is required);
- SMS and Call simulator;
- SNMP remote control.



### Caution

- Some features can be limited by the licence file. For detailed information on the current licence state see Subs. 2.4 Licence Limitations.
- For factory settings of the eCPU refer to Subs. 3.1.

It is possible to change the basic IP settings locally via a serial console. For description of the serial console configuration see below.

## Serial Console Access

The console system is arranged as a set of nested menus. By selecting a menu item you either get into a submenu, or have the required operation executed, or set the selected parameter.

### Serial Connection Settings

Default parameters of the eCPU serial connection:

Item	Value
Baud rate	115,200bps
Bits	8
Parity	None
Stop-bits	1
Flow control	None

For communication using the RS232 serial connection set the JP2 jumper on the CPU board correctly. For details refer to Subs. 2.1 – Enhanced CPU Board, Configuration Jumpers.



### Tip

- To communicate with the basic and enhanced CPUs via a serial interface at a time, use COM1 for communication with the enhanced CPU and COM2 (on the AUX card) for communication with the basic CPU.

## Serial Console

When the gateway is powered on, the main menu should get displayed after terminal connection. To enter the main menu press .

```
StarGate Exp Unit 0-2-0          Main Menu          09-0460-0016
  Option          Value          Description
1 - Configuration      [ menu ] - General configuration
2 - Set Admin password - Set administration password
3 - Help              - Display help for console settings
4 - Reboot            - Reboot
Enter an option number, <ESC> previous menu
>
```

If you select a submenu, this submenu gets displayed. Now you can select items from the selected submenu or push the ESC button for return.

Below is a brief survey of these menus only.

- **Main menu**  
This menu appears after the serial cable is connected to the eCPU (sometimes you must press Enter). The main menu contains the following items:
- **Configuration menu**  
Use this menu to configure the Ethernet interface and serial console:
  - Network – contains eCPU Ethernet interface settings. Set the static IP address or activate the DHCP service support. You are recommended to reboot the eCPU after changing any of the IP settings.
  - Console – basic settings of the serial link.
  - Reset settings – here restore the factory settings of the eCPU.
- Set Admin password – here you can change the Admin password locally.
- Reboot – here you can reboot the eCPU (e.g. in the case of IP setting changes).

After making correct IP settings, you can connect the eCPU to your Ethernet network and perform complete configuration via a user-friendly web interface.



## Web Browser Access

While the serial console interface enables you to change the basic gateway parameters only, the web browser gives you access to all parameter settings and services available in the gateway. To establish connection with the gateway, enter the gateway IP address into the Internet address setting line in the browser, e.g.:



If you have connected all parts properly and set the correct gateway and PC IP addresses, the request to enter the access user name and password should get displayed.



### Caution

- The manufacturer supplies the gateways with a predefined default user account **Admin** without having set its default password. Mind the Upper/Lower Case while entering the user name and password! The first thing you should do for safety reasons after putting your gateway in operation is to change the administrator password.



Web Administration Login Page

After a successful login you get onto the main page of the web application. The window is divided into three parts:

- Left text menu – text with links to available eCPU features.
- Main graphics menu – icons with links to available eCPU features.
- Section with system information:
  - Current firmware version;
  - eCPU serial number;
  - Basic CPU serial number to which the eCPU licence applies;
  - Web interface log-out icon.

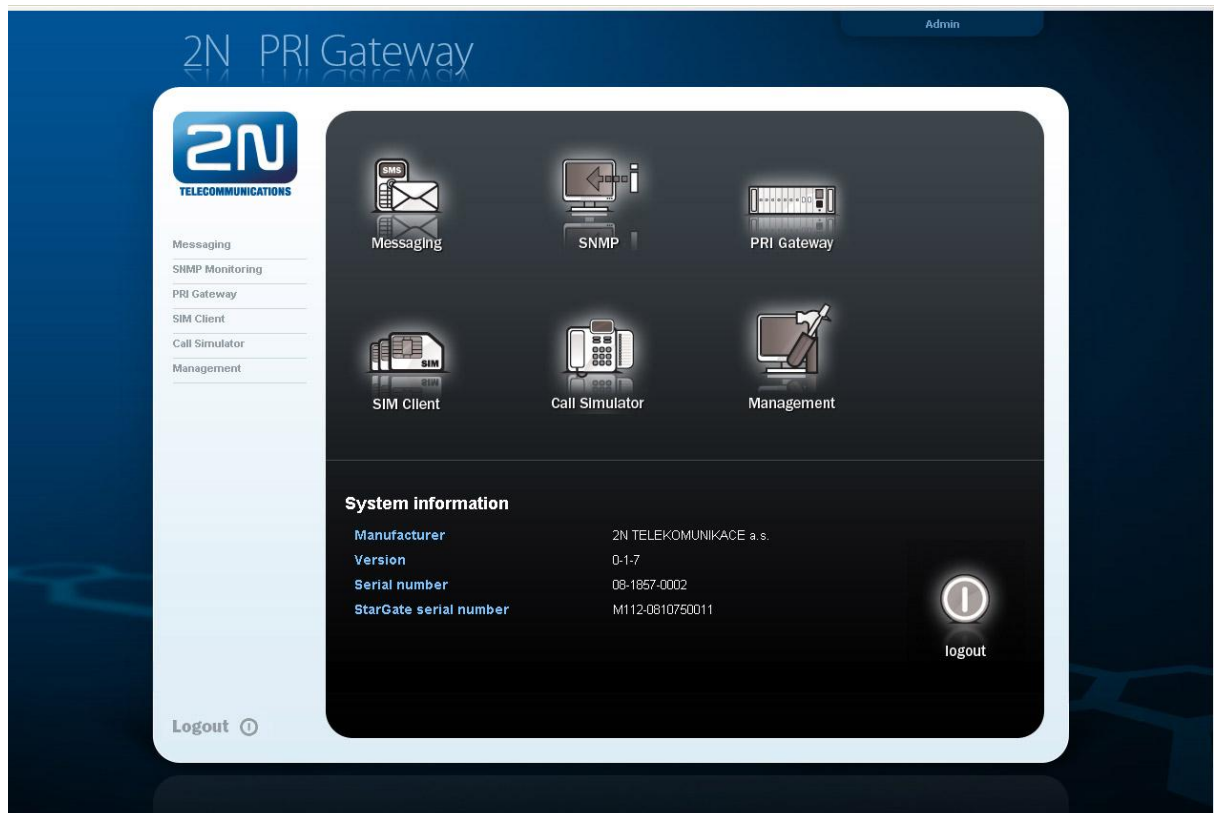

Main Menu

**Tip**

- The active web session is closed after 2 minutes of inactivity or upon the web browser closing.

**Note**

- Remember to type the **Serial number** and **StarGate serial number** while requesting for a new licence type.

**Icons**









The web interface uses the icons located on the bottom of the configuration page. The table below describes these icons.



Save settings



Reset settings

	Load default settings
<b>Home</b> 	Back to home page
	One step back
	Add new user
	Remove selected item(s)
	Add item
	Refresh item
	Save to local disk

## Messaging

This section contains settings for sending/receiving SMS via the POP / SMTP protocols. The main menu is divided into eight SMS delivery groups, which correspond with the GSM outgoing groups in the basic CPU settings (see 3.4 – GSM Outgoing Groups).

**SMS delivery group 1**

- VIP numbers
- SMTP IP access

SMS delivery group 2

SMS delivery group 3

SMS delivery group 4

SMS delivery group 5

SMS delivery group 6

SMS delivery group 7

SMS delivery group 8

### Modify SMS delivery settings

#### Distribute incoming messages

Parse contents:

Message response:

VIP numbers:

Deliver SMS to user:

#### Automatic answers delivering

Answer arrives until   (max. 6 hours)

#### SMTP/POP3 server settings

Email domain name

POP3 email subject

Maximum number of SMS per email

SMTP IP access control

Allow 16-Bit SMS

Allow SMS concatenating

---

## SMS Delivery Group #

---

This section contains configuration for sending/receiving SMS via GSM outgoing group # (1-8):

- **Distribute incoming messages:**
  - Parse contents – enable/disable the item.
  - Message response – enable/disable SMS Auto Clip Routing for incoming SMS.
  - VIP numbers – enable/disable the table of numbers (CLIP) for incoming SMS. An incoming SMS with a CLIP saved in the VIP list will be automatically forwarded to **Deliver SMS to user**.
  - Deliver SMS to user – select the users for the **VIP numbers** table and incoming SMS with no record in the SMS Auto Clip Routing table. For how to manage the users see Subs. Management.
- **Automatic answer delivering**  
A parameter for SMS Auto Clip Routing, which defines the maximum delay between the SMS sending and SMS answering from one and the same GSM number.
- **SMTP / POP3 server settings**  
Parameters for SMTP and POP3 (SMS sending/receiving) protocols:
  - Email domain name – domain for user authorisation (username@email\_domain\_name).
  - POP3 email subject – subject of received e-mail, which contains an incoming SMS message. For description of the symbols see the table below:

String	Meaning
%n	Number (CLIP) of SMS sender
%u	Username of SMS addressee
%d	SMS receipt date

- **Maximum number of SMS per email**  
The maximum count of SMS messages to be delivered in one e-mail message.
- **SMTP IP access control**  
Enable/disable the IP access restriction according to the **SMTP IP access** table.
- **Allow 16-bit SMS**  
Enable/disable the 16-bit format for SMS.
- **Allow SMS concatenating**  
Enable/disable division of an SMS longer than 160 chars.
- **Insert email sender to SMS**
- **Insert email subject to SMS**



### Caution

- The format of the authorisation username requested by your e-mail client is user\_name@email\_domain\_name!

## VIP Numbers

A table of numbers (CLIPs) of SMS senders for a selected SMS delivery group. This table is designed for fixed routing of SMS from selected SMS senders to selected SMS users.



### Note

- The table of VIP numbers is used only if the **VIP number** parameter in the SMS delivery group is activated!

### Set VIP number

VIP number	Description			
+42060112345	Office 21			<input type="checkbox"/>

## SMTP IP Access

A table of IP addresses that are granted access to the eCPU via the SMTP protocol. With this table, it is possible to restrict access to the eCPU via the SMTP to prevent potential hacking.

Set IP address				
IP address/Mask	Description			
192.168.1.1/24	MS Outlook1			<input type="checkbox"/>



### Note

- The SMTP IP access table is used only if the **SMTP IP access control** parameter in the SMS delivery group is activated!

## Additional Information

### Settings for sending/receiving SMS via SMTP/POP3 protocols

The gateway's internal POP3 server provides SMS downloading from the eCPU via e-mail. Authorisation goes through the USERNAME and PASSWORD, which are used for registration to the web-based interface of the eCPU. Every SMS is changed into e-mail in the **Inbox** directory after successful authorisation of the CPU. The information includes the SMS sender's telephone\_number@domain name and the SMS receiver's telephone\_number@domain name (to set the domain name use the web interface; the e-mail header and subject of the message are filled in according to the CPU settings).

An already read message can be deleted from the POP3 server. You can delete a message from the gateway eCPU or mark it as already read, but the POP3 server cannot see it.

The server awaits e-mail in the format Text/Plain, Text/HTML, Multipart/Mixed or Multipart/Alternative. From a message in the Text/HTML format, only the body of the HTML message without formatting is put into the SMS message. From Multipart/Mixed and Multipart/Alternative messages, only the first part of the message is used, enclosed between strings and mentioned in the header under the **Boundary** name. The server only supports messages in the 7-bit format encoded according to ISO-8859-1 or the 16-bit format encoded according to Unicode UTF-8 (messages with different encoding could be illegible when received in the SMS format).

## SNMP Monitoring

This function is not available yet.

## PRI Gateway

A section for comfortable configuration and administration of the basic CPU of the gateway. The communication between the eCPU and basic CPU is via the Telnet

protocol externally. Before you start configuring and managing the gateway set the correct IP address, username and password of the basic CPU (see Subs. 3.4 Off-Line Configuration).

The gateway menu is divided into four sections:

- **Gateway control**  
Information on the gateway and on-line commands (e.g. firmware upgrade).
- **Gateway configuration**  
A complete configuration of the gateway.
- **Reset**  
Items for the gateway remote restart and restart with factory setting restoration.
- **Configuration back-up**  
Option to download the current basic CPU configuration.



### Tip

- All the configuration features are similar to those used in the configuration tool. Before using the web interface please read Subs. 3.4 carefully.

## Gateway Control

- **Firmware / Licence**  
A section for remote firmware and licence upgrade to the basic CPU. It also provides an option to check the current firmware version and licence limitations of the basic CPU.

**Note**

- The firmware upgrade from the web interface works only if this feature is activated in the basic CPU configuration and the remote port is set to 2222.

- **Date / Time**  
An option to set the current time and date for the basic CPU.
- **LOG file**  
A window for downloading LOG messages from the basic CPU.
- **Statistics**  
Provides the current state of call statistics of the gateway.
- **Actual calls info**  
The current state of active calls through the gateway.
- **Connection state**  
The current state of all local / remote configuration sessions.
- **Dynamic CLIP routing table**  
The current state of the Auto Clip Routing table.
- **SIM card statistics**  
The current state of call limits of the SIM cards used.
- **GSM module status**  
The current state of all wireless engines of the gateway.

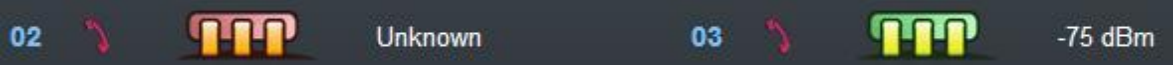



## Gateway Configuration

This section is identical with the configuration via the configuration tool (Subs. 3.4).

### VoIP parameters

**VoIP functions**

Day of deleting statistics on VoIP (every month):

**SIP protocol settings**

Send 180 Ringing instead of 183 Session progress:

Send 200 OK instead of 180/183:

Send 200 + Bye:

**SIP registration**

Registration expires [s]:

Reattempt registration:

Registration domain (realm):

Name:

Username:  (Write only)

Password:  (Write only)

All settings are saved to the basic CPU via the Telnet protocol. Some changes can cause the gateway restart and make the basic CPU temporarily unavailable.

## SIM Client

It is a functional part of the 2N<sup>®</sup> SIM Star system. This process is designed for translation of data streams of remote SIM cards to GSM modules and vice versa.

- **Information**

Information on the SIM Client software version (upgrade is possible as part of the eCPU firmware).

Informations	
Version:	1.00.21
Serial number:	09-0460-0016

- **Channels**

The current state of all wireless channels connected to 2N<sup>®</sup> SIM Star.

- **Settings**

Settings of the username, password and IP port used for communication with 2N<sup>®</sup> SIM Star.

- **Restart**

Possibility to restart the SIM Client process.

## Call Simulator

An automatic generation of outgoing / incoming calls and SMS messages. With these functions (Call simulator, SMS simulator) activated, the system automatically (according to the predefined rules) sets up calls between the wireless modules and also sends/receives predefined SMS to/from the wireless modules.



### Caution

- A valid licence is required for a correct function of the SMS and Call simulators. You have to have a call simulator licence for the Call simulator and an additional SMS licence for the SMS simulator. While uploading the licence, check whether the respective feature is enabled in the **Management** menu.
- By activating this function you may increase your call bill (real calls and SMS).

It is necessary for you to know the phone numbers and IMSI of the SIM card used for a correct function of the Call / SMS simulators. There are two ways of importing these numbers to the system:

- **Using local IMSI / Phone list**  
Prepare a CSV file (divided by space) for data importing with all the required SIM card data.  
  
230013001547875 731123446  
230014120587987 605123446
- **Using remote database of 2N<sup>®</sup> SIM Star Server**  
Add the remote server IP address and the IP port (default is **12349**). Make sure that this feature is also enabled on 2N<sup>®</sup> SIM Star Server (**SIM server management > Connections**).

#### IMSI/Phone servers

Call simulator needs to know phone numbers of SIM cards used on called side. IMSI/Phone servers can distribute IMSI numbers of SIM cards and assigned phone numbers. Another facility is using of IMSI/Phone list. You can define servers they offer IMSI/Phone distribution service. For example SIM Star Server can do this.

#### Server 1

IP:

Port:

## Configuration

The configuration is divided into two sections. You can enable/disable each function independently.

- **Call simulation**  
Settings for automatic call generation between the gateway wireless modules.
- **SMS simulation**  
Settings for automatic SMS generation between the gateway wireless modules.

### Call simulation

- **Delay between calls**  
Time in minutes between two automatic calls. You can choose **Hard** (every defined count of minutes) or **Random** (randomly between two intervals in minutes).
- **Answered calls**  
Ratio of connected calls. Example: If you set 50%, every other call will only be answered.
- **Time of ringing**  
Length of ringing calls before automatic connection or call end.
- **Time of answered calls**  
Length of active / connected calls between two modules.
- **Module choice method**  
A way of using wireless engines for calls:
  - Cyclical – wraparound using of defined wireless engines;
  - Random – random use of defined wireless engines.
- **Calling / called module range**  
A group of wireless engines to be used for the Call simulator.

**Settings**

**Call simulation**

Enabled:

Delay between calls [min]: Hard 2 1

Answer calls [%]: 63

Time of ringing [s]: Random (from - to) 12 28

Time of answered calls [s]: Random (from - to) 32 50

Module choose method: Cyclical

Calling modules range: 0 31

Called modules range: 0 31

**SMS simulation**

For SMS simulation the messaging function have to be activated!

Enabled:

Delay between messages [min]: Hard 2 1

### SMS simulation

- **Delay between messages**  
Time in minutes between two automatic SMS. You can choose **Hard** (every defined count of minutes) or **Random** (randomly between two intervals in minutes).
- **Module choice method**  
A way of using wireless engines for SMS messages:
  - Cyclical – wraparound using of defined wireless engines;
  - Random – random using of defined wireless engines.

- **Sending / Receiving module range**  
A group of wireless engines to be used for the SMS simulator.



### Note

- The SMS simulator uses SMS messaging for sending/receiving SMS. All received SMS messages are saved into the **sms** account.

## Management

The status screen for all the above mentioned functions and additional eCPU configuration. The window is divided into four sections:

- **Licence**  
Information on the current licence state and potential licence expiration.
- **Times**  
The current system time and up time of the eCPU.
- **System status**  
States of all eCPU functions. You can enable/disable each function manually.



### Caution

- You have to activate the requested function before use.

- **Icon list**  
Additional eCPU configuration and management.

**Licence**

<b>Company</b>	
<b>E-mail</b>	
<b>Users</b>	20 (used 8)
<b>Expires (hours)</b>	Never (68)

**Times**

<b>Process uptime</b>	03:24:23
<b>System time</b>	01/16/2000 08:10:14

**System status**

Messaging:	LICENCED	DEACTVATED	<a href="#">activate</a>
SNMP:	NOT LICENCED		
SIM Client:		ACTIVATED	<a href="#">deactivate</a>
Call simulator:	LICENCED	ACTIVATED	<a href="#">deactivate</a>
CDR downloader:	LICENCED	ACTIVATED	<a href="#">deactivate</a>
StarGate:	LICENCED		

## Icon List

- **About**  
Information on the manufacturer.
- **Statistics**  
Not implemented yet.
- **Network**  
The eCPU IP settings. If you save wrong parameters, you can restore the correct IP parameters using a serial console.
- **Gateway CPU**  
The IP address and access data of the gateway basic CPU.
- **Licence**  
An item for uploading a new licence for the eCPU (NOT the main CPU).
- **Firmware**  
An option to upload new firmware (format PGW-x-x-x) for the eCPU. Please be patient in the case of a narrow connection bandwidth because the firmware size is about 9MB.



### Caution

- Be sure to use original and undamaged firmware files for the firmware upload to avoid gateway function problems! For the latest firmware version see our websites ([www.2n.cz](http://www.2n.cz)).

- **Time**  
The eCPU does not contain a clock generator of its own. It is necessary to synchronise it from any place. You can choose an NTP server or the basic CPU of the gateway.
- **LOGs**  
Here you can set and download the eCPU status log records.
- **Configuration back-up**  
An option to download the complete eCPU settings.
- **Restart**  
Reboot of the eCPU. You are recommended to use this function instead of the hard reset by switching off / on the whole system.
- **CDR**  
An automatic CDR download from the basic CPU to the microSD card located on the eCPU board (see Subs. 2.1 – enhanced CPU Board). When the CDR function is activated, all CDR will be automatically downloaded and saved onto a microSD card. The saved CDR are available for download in this section of web interface.



### Caution

- The microSD card must be formatted according to the FAT32 system!
- The CDR function will not start until the SD card is inserted in the system!

### ■ User accounts

Management of the users that can access the web interface or use SMS services. The users are divided into nine groups. Group 0 is for service accounts, groups 1-8 are designed for SMS delivery groups 1 – 8.



### Tip

- If you forget the Admin user password, you can restart the gateway with restoring the factory settings using a serial console.

Service account	Description
Admin	Account for configuration eCPU
simstar	Account for SIM Client
sms	Default user for SMS and SMS simulator

The default accounts are added by the default settings (one per User group). Click on the **Add user** icon to add a new account to the system.

### Add user

User name:

New password:

Confirm new password:

Description:

## 3.6 2N® External Routing Machine Configuration

### Installation

---

#### CD Image

An automatic installation CD (part No. 507424E) has been created for installation purposes. This installation CD automatically prepares the system and installs the requested application.

#### Hardware Requirements

##### Minimum PC Hardware Requirements

<b>Processor</b>	Intel P4, 2.4GHz or higher
<b>RAM</b>	2048 MB RAM
<b>HDD</b>	60GB SATA
<b>CDROM</b>	Only CD-R
<b>LAN</b>	Ethernet 100BaseT

#### Installation Procedure



##### Caution

- By using the installation CD you remove ALL data from the hard drive!

This installation is automatic and requires a very low user interaction.

Follow the instructions below to install a perfectly working system.

Set your PC to use the CD ROM as the default boot device.

Place the installation CD into the CD ROM.

After starting your PC, you will get the following screen. You can choose any of the available booting options. Automatic installation is the first option and will start in 3 seconds.

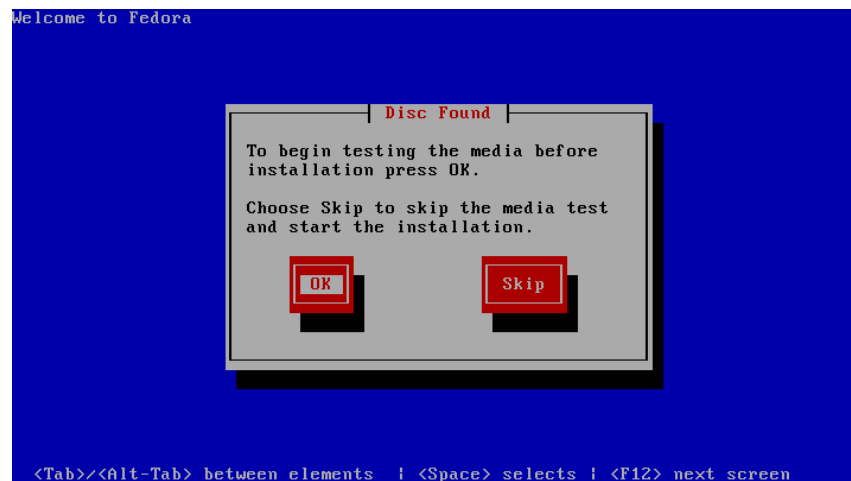

You can test the installation CD before installation. Choose **OK** to test the CD or **Skip** to continue the installation process.

The installer will automatically format the hard drive and install all system files. When the installation is finished, the installer will wait for reboot confirmation. Press ENTER to continue.

Remove the CD from the CD ROM and let the new system boot.

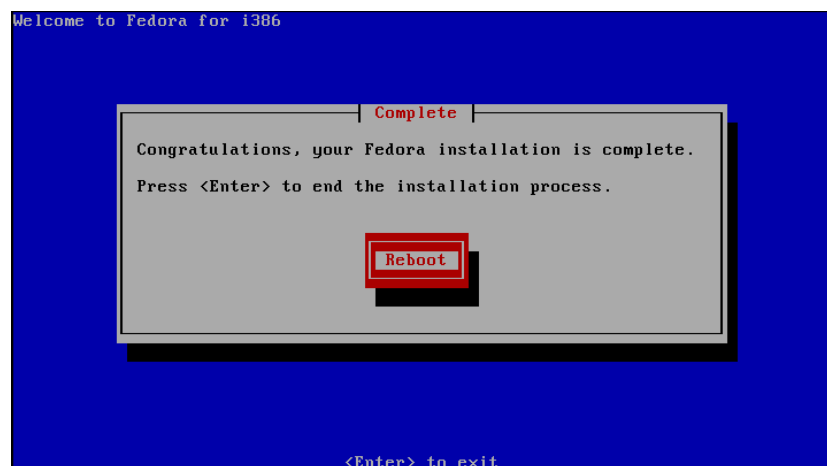



To finish the system settings log in as the [Admin](#) user with the [Admin](#) password. The wizard will help you set the network and install the package correctly.

---

## Network Settings

---

You can set the network during the first login. A graphical wizard will help you set the IP address, network mask and default gateway. Use **TAB** to move between options. Use **SPACE** to select or unselect options. You can also change the IP by running the command set-up.

---

## Time Zone and Time Synchronisation

---

Because the routing rules are based on time and date, be sure to set the correct time zone and synchronise time. For time synchronisation use the NTP protocol and so you need the Internet connection.

---

## Package Installation

---

Choose the package to be installed. You can choose either the 2N® ERM or 2N® SIM Star Server application.

---

# Configuration

---

## Licence

The ERM licence is per gateway connection. The licence is generated by the 2N Technical Support and based on the gateway serial number.

For a correct function, copy the licence file into the [/etc/erm](#) directory.

## Gateway Connection

The ERM configuration file is located in [/etc/erm/erm.conf](#).

The configuration file consists of the following sections:

- MAIN section for general configuration;
- GATEWAY section for information related to the gateway, the maximum number of connected gateways is 100.

---

## MAIN Section

---

The MAIN section contains the following values:

- Thread count - count of threads working with the database (please do not change this value to avoid ERM error, default value=10).

- DB\_Host – database server (please do not change this value to avoid ERM error, default value=/tmp).
- DB\_Database – the database name (please do not change this value to avoid ERM error, default value=erm1).
- DB\_Username - username for database access (please do not change this value to avoid ERM error, default value=erm).
- DB\_Password - user password for database access (please do not change this value to avoid ERM error, default value=no password).

---

## GATEWAY Section

---

The GATEWAY section contains the following values:

Key	Value	Description
<b>Enabled</b>	0 or 1	Activates (1) or deactivates (0) use of gateway.
<b>IPaddress</b>	IP address in format xxx.xxx.xxx.xxx	Remote GSM gateway IP address. This connection has to be set for ERM remote control.
<b>Import</b>	IP port number	Remote gateway communication port (default=23).
<b>Username</b>	String	Username for gateway access through Telnet protocol (default=2n).
<b>Password</b>	String	Password for gateway access through Telnet protocol (default=2n).
<b>Inc_table</b>	inc001 to inc100	Name of the table that includes record for incoming GSM call filtering. One table may be shared by multiple GSM gateways.
<b>Inc_table_enabled</b>	True or False	Enables (True) or disables (False) filtering of incoming calls.
<b>Other_CLIP</b>	0 or 1	Determines whether an identified GSM CLIP shall be rejected (0) or received (1).
<b>Out_table</b>	out001 to out100	Name of the table used for outgoing call routing. One table may be shared by multiple GSM gateways.
<b>Out_CLIP_table</b>	clip001 to clip100	Name of the table used for outgoing call routing. One table may be shared by multiple GSM gateways.
<b>Out_table_enabled</b>	True or False	Enables (True) or disables (False) use of Out_table.
<b>Log</b>	0 or 1	Activates (1) or deactivates (0) LOG generation.
<b>Debug</b>	0 or 1	Activates (1) or deactivates (0) debug generation.
<b>Release_CAU</b>	Number 1-255	ISDN releases CAU which is sent if a call is rejected (default=21).

---

## Example of Configuration Settings

---

```
[MAIN]
Interface    = eth0
ThreadCount = 10
DB_Host     = /tmp
DB_Database = erm2
```

```

DB_Username = erm
DB_Password =

[GATEWAY001]
Enabled = 0
IPAddress = 127.0.0.1
IPport = 23
Username = 2n
Password = 2n
Inc_table = inc001
Inc_table_enabled = True
Other_CLIP = 1
Out_table = out001
Out_table_enabled = True
Out_CLIP_table = clip001
Log = 1
Debug = 1
Release_CAU = 21

```

## ERM Control

The [erm](#) user is used for administration purposes. To log in as the erm user use the [ermserver](#) password. The ERM is controlled and administered by the erm utility. To launch this utility use the following syntax (the statement values are not case sensitive):

### erm statement parameters

Statements	Action
<b>start</b>	Launches the ermserver service. If the service is running, it writes out a report and terminates operation.
<b>stop</b>	Terminates the ermserver service. Unfinished requests, if any, are completed.
<b>restart</b>	Restarts the ermserver service.
<b>Status</b>	Writes out the ermserver service status, i.e. whether or not it is running.
<b>import &lt;db_name&gt; &lt;CSV_file&gt; &lt;replace_duplicates&gt;</b>	Imports a new record into database table: <b>&lt;db_name&gt;</b> - name of the database table to be used for import. <b>&lt;CSV_file&gt;</b> - name of the CSV file to be used for import. If the file is unavailable in the current directory, the full path has to be listed. The CSV file values are separated with a comma (0x2C). The structure of all related tables is described in the ERM database structure section. <b>&lt;replace_duplicates&gt;</b> - sets whether duplicate lines should be replaced (True) or kept (False).  Example of usage: <b>erm import clip001 clip001.csv true</b>
<b>export &lt;db_name&gt; &lt;CSV_file&gt;</b>	Exports the database table to the CSV file. Example of usage: <b>erm export clip001 clip001_backup.csv</b>
<b>Erase &lt;db_name&gt;</b>	Deletes the content of a selected database table. Example of use: <b>erm erase clip001</b>
<b>Copy &lt;source_db_name&gt; &lt;dest_db_name&gt;</b>	Copies the database table: <b>&lt;source_db_name&gt;</b> - name of the source table; <b>&lt;dest_db_name&gt;</b> - name of the destination table. Example of usage: <b>erm copy clip001 clip002</b>

## Description of ERM Function

After start, the ERM is connected automatically to the defined GSM gateways, activating the external call routing process in them. During this process, the GSM gateway automatically sends information on any new call to the ERM and awaits reply with call instructions within 2 seconds. If no reply comes from the ERM within this timeout, the call is routed according to the internal routing tables.

The functional diagram below shows the request processing procedure:

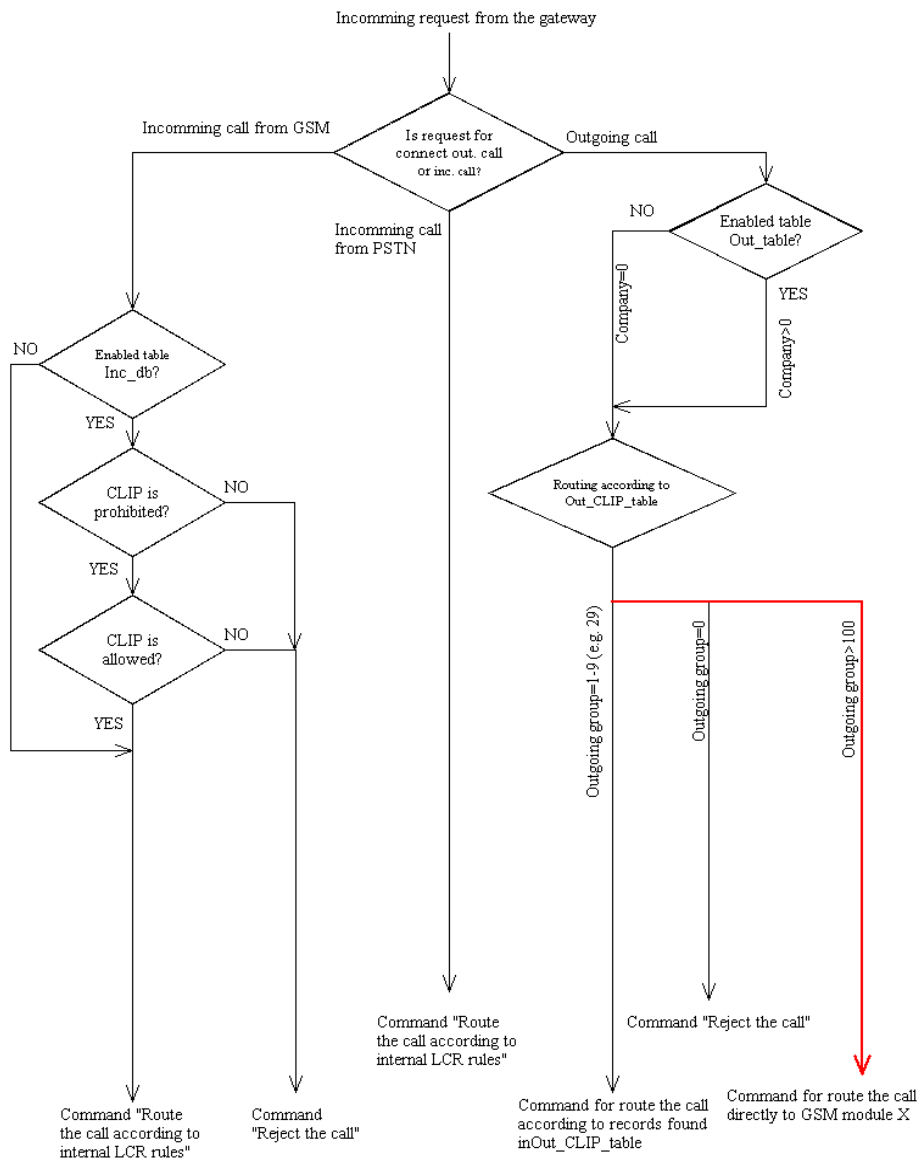

## ERM Database Structure

As mentioned in the ERM Control subsection above, a csv file with a specific structure has to be used for import to <db\_name>. The structure for each <db\_name> is described below.

## Database erm1 Tables

Table	System name
inc_table	inc000 to inc100 (step 1)
out_table	out000 to out100 (step 1)
clip_table	clip000 to clip100 (step 1)

## Table Structures

### Structure of inc\_table

This table is used for filtering incoming calls from GSM networks.

CLIP	Restriction	Time from	Time to	Day
+420605234354	1	00:00	12:00	1234567
+420775234091	0	12:00	24:00	1234567

- **CLIP**  
Enter the strings to be directly compared with the CLIP received.
- **Restriction**  
Enter the value to be assigned to each CLIP determining whether the incoming call with the CLIP shall be rejected (0) or received (1).
- **Time from**  
Set the beginning value of the time interval (hh:mm) for the selected rule.
- **Time to**  
Set the end value of the time interval (hh:mm) for the selected rule.
- **Day**  
Define a day in the week on which the rule shall be applied (1= Monday, ..., 7 = Sunday).

### Structure of out\_table

This table is used for identification of the subgroup from which the call is coming. The search result is used for search in the clip\_table.

CGP	Company	Time from	Time to	Day
261301__	1	00:00	12:00	1234567
2353215__	2	12:00	24:00	1234567
261333111	100	00:00	24:00	1234567
261333222	101	00:00	24:00	12345

- **CGP**  
Enter the strings to be directly compared with the CLIP received. The '\_' character is used as a masking character for one numeric character.
- **Company**  
Set the value to be assigned to each CGP determining to which subgroup the CGP is assigned. If there is no match, the received CGP is assigned to subgroup 0. In case **Company** is set to a value higher than 100, the call is routed directly to a GSM module instead of a group.
- **Time from**  
Set the beginning value of the time interval (hh:mm) for the selected rule.
- **Time to**  
Set the end value of the time interval (hh:mm) for the selected rule.

- Day**  
 Define a day in the week on which the rule shall be applied (1= Monday, ..., 7 = Sunday).

#### Structure of clip\_table

Prefix	Company	Change prefix	Delete last	Out group	Time from	Time to	Day
605205697%	1		0	129	00:00	12:00	1234567
605205697#%	4		1	9	12:00	24:00	1234567
605%	1	#31#	0	129	00:00	24:00	1234567
605%	2	+420	0	349	00:00	24:00	1234567
0605%	3	-#31#	0	59	00:00	24:00	1234567
608%	1	#31#+420	0	0	00:00	24:00	1234567
%	1		0	9	00:00	24:00	1234567
%	100		0	G10	00:00	24:00	1234567
%	101		0	G1	00:00	12:00	1234567
%	101		0	G12	12:00	24:00	1234567

- Prefix**  
 Define the received called number or a part of it (the number is checked from the left).
- Company**  
 Use this parameter to define to which subgroup the rule is to be applied.
- Change prefix**  
 Use this parameter to modify the number to be dialled. The '-' character removes one character from the left side of the called number. The other characters are added to the called number beginning.
- Delete last**  
 Use this parameter to remove characters from the right-hand side of the called number. The value defines how many characters should be removed.
- Out group**  
 Use this parameter to specify the outgoing group for call routing. If the group is set to 0, the call will be rejected.
- Time from**  
 Set the beginning value of the time interval (hh:mm) for the selected rule.
- Time to**  
 Set the end value of the time interval (hh:mm) for the selected rule.
- Day**  
 Define a day in the week on which the rule shall be applied (1= Monday, ..., 7 = Sunday).

## 3.7 2N® SIM Star System

### Product Purpose

---

2N® SIM Star offers:

- Central administration for all of your SIM cards;
- Central and safe location for all of your SIM cards;
- Elimination of SIM card replacement costs for GSM/UMTS gateway locations;
- High capacity for your SIM cards due to extensive scalability;
- Simple integration in your existing IP solution due to standard Ethernet interface connection.

### 2N® SIM Star Key Components

---

- eCPU - SIM Client – a card designed for the 2N® StarGate / BlueStar / BlueTower gateway. The card converts data from/to the GSM/UMTS card on the Ethernet interface.
- SIM Star GSM/UMTS board – a card designed for the 2N® StarGate / BlueStar / BlueTower gateway. This card replaces the existing GSM/UMTS cards in the respective gateway. The new solution enables connection to the SIM Client card.
- SIM board – includes as many as 32 SIM cards, converts data from/to the Ethernet interface.
- SIM board box – a 3U rack designed for up to 18 SIM boards. The SIM box works as a traditional Ethernet switch that provides comfortable connection and storage of SIM boards.
- 2N® SIM Star Server - a rack-mounted PC that provides seamless integration of the system and allocates the GSM/UMTS module SIM cards according to the user-defined rules. 2N® SIM Star Server includes a web interface for easy and user-friendly system configuration and control.

### SIM Client Configuration

---

All configuration steps of the SIM Client process are taken via the eCPU web interface (see Subs. 3.5 – SIM Client). The SIM Client communicates with the other 2N® SIM Star parts via an Ethernet interface and using the following IP ports:

IP port	Description
22 / SSH	Remote system upgrade
1500 / TCP	Connection with 2N® SIM Star Server
10000 – 100031 / UDP	Connection with SIM boards
12349 / TCP	Connection of Call simulator to 2N® SIM Star Server

Remember to activate and correctly set the SIM Client process to ensure a proper function of the gateway in the 2N® SIM Star system.

The 2N® SIM Star system takes over some features from the basic CPU system. For additional information refer to the 2N® SIM Star user manual.

## 3.8 Voice CallBack Centre Configuration

The Voice CallBack Centre (VCC) adds new features to the standard CallBack function of the gateway. With the VCC you can increase the count of users and add CallBack time limitations to each user. This software is an optional part of the system. For additional information please contact your dealer.

### Function Scheme

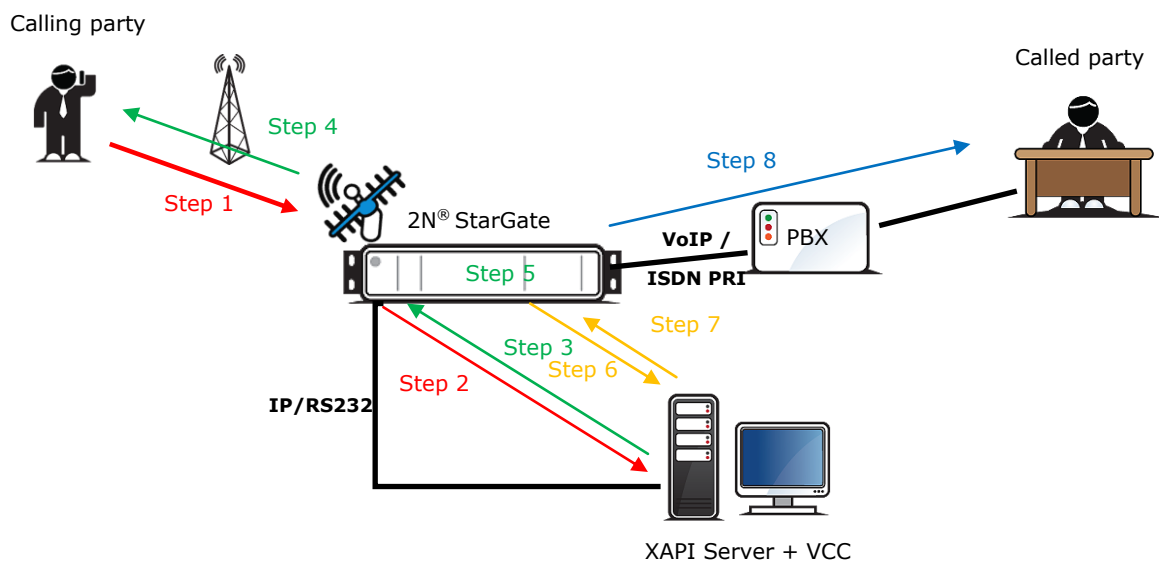

- 1) The calling party starts dialing and ringing the gateway. After a few seconds, an unanswered call is hung up.
- 2) The gateway sends the user authorisation request to the VCC.
- 3) The VCC authorises the calling party.
- 4) The gateway starts calling back to the calling party and waits for call connection.
- 5) The calling party receives a voice message for DTMF dial-in and the dial destination (called party number).
- 6) The gateway sends the destination authorisation request.
- 7) The destination is authorised.
- 8) Dialling to the called party starts and the call is connected.





### Note

- Saving of outgoing successful calls to the CDR has to be activated for a correct function of the VCC. The VCC automatically downloads the CDR and uses them for setting the VCC user call limits.

## Installation and Licences

The Voice CallBack Centre communicates with 2N<sup>®</sup> XAPI Server and 2N<sup>®</sup> XAPI Server translates the communication to a defined interface (Telnet, RS232).

### 2N<sup>®</sup> XAPI Server Configuration

The installation file (setup.exe) is located on the installation CD. After successful installation start 2N<sup>®</sup> XAPI Server.

The first thing you should do is establish connection between your 2N<sup>®</sup> StarGate / BlueStar / BlueTower gateway and the PC where 2N<sup>®</sup> XAPI Server is installed.

Close all windows except for the main 2N<sup>®</sup> XAPI Server window. In main menu, click on **Set** and **Module-PBX**. In the PBX settings, disable the **COM port** by selecting '---' and push **OK**.

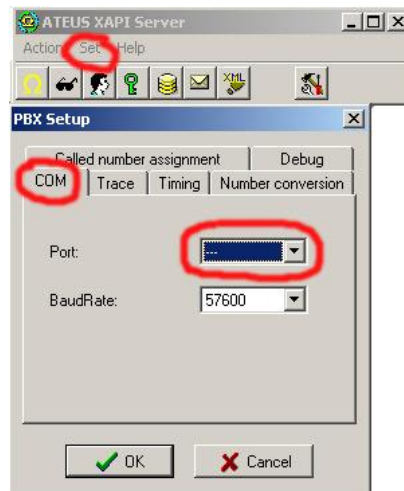

Now set the **COM** port (or use the TCP/IP mode) to which the gateway is connected.

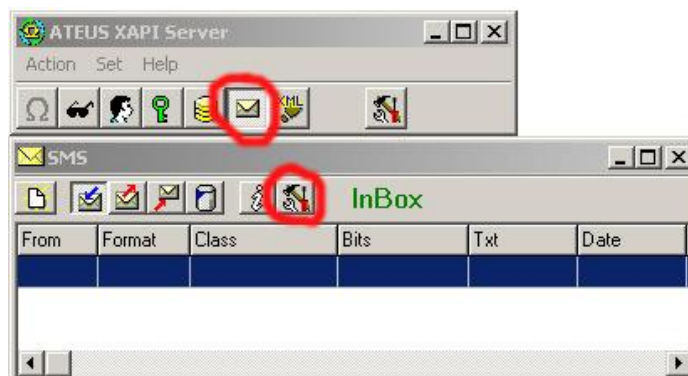

The figure below shows an example of correct connection settings for the gateway PRI.

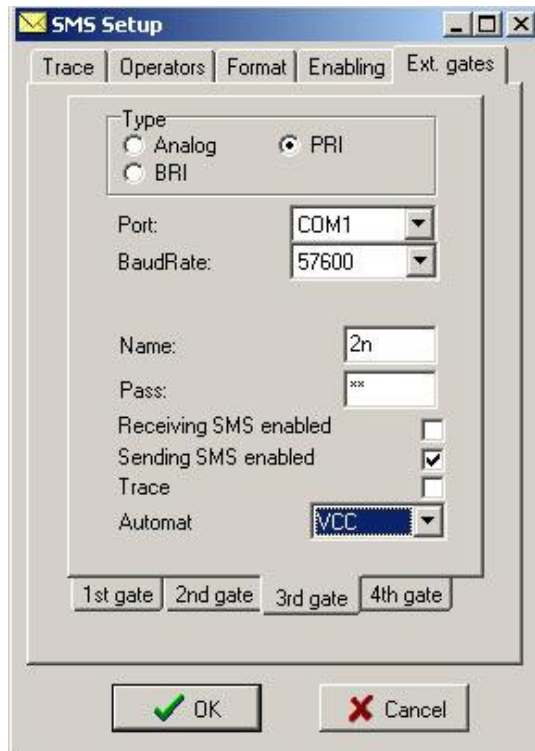

If you have set all the parameters correctly, you will see the signal status of the GSM modules in the 2N<sup>®</sup> XAPI Server status window.

## 2N<sup>®</sup> XAPI Server Licences

To activate the Voice CallBack Centre, enter the valid licence code into 2N<sup>®</sup> XAPI Server. This licence is generated by 2N according to the requested service and the basic CPU serial number in the connected gateway. The licence contains two codes to be entered. For how to add a new licence see the figure below:

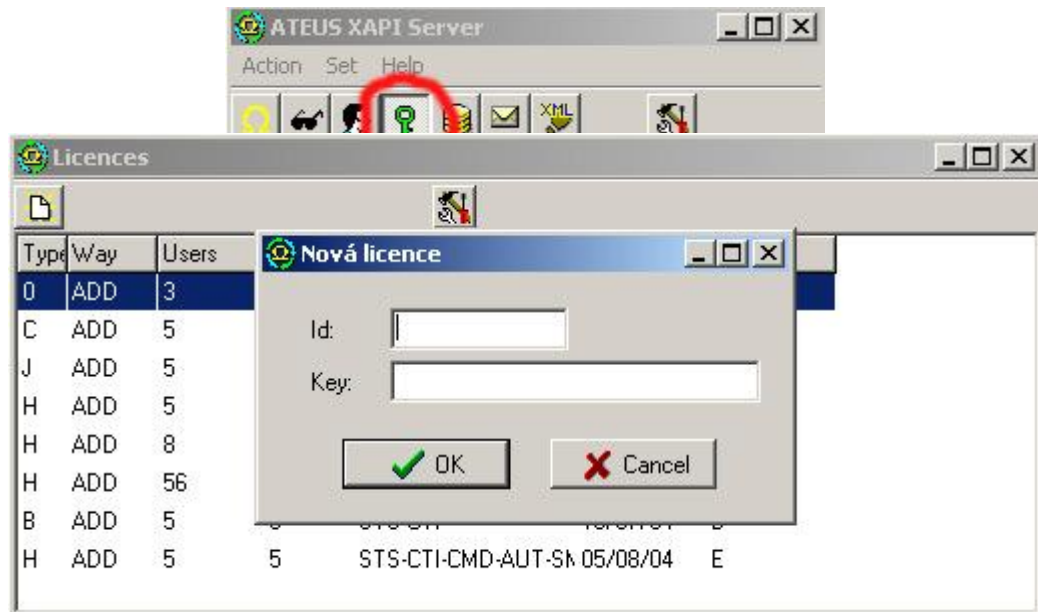

Create a new user to be used for communication between the Voice CallBack Centre and 2N® XAPI Server.



### Tip

- In case you have not connected the gateway you will not succeed in adding a licence to 2N® XAPI Server (getting the BAD LICENCE response!).

The user creating procedure is very similar to the licence adding one. Please follow the figures below:



Click on the USER icon to open the window with all active users. In the USER window, click on the second icon from the left and then on the icon for a new user.

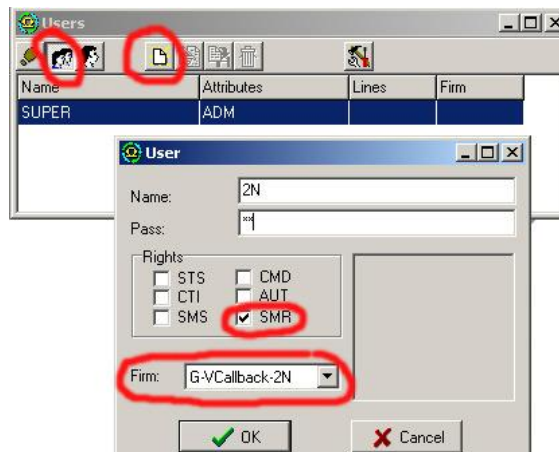

In the USER window select the correct **Firm**, activate the **SMR** attributes and add the username and password. The username and password must be entered into the Voice CallBack Centre.

## Voice CallBack Centre Connection Settings

Having installed the Voice CallBack Centre software successfully, set communication with 2N<sup>®</sup> XAPI Server. As shown in the figure below, set the username and password (the same user account as in 2N<sup>®</sup> XAPI Server) and the IP address of the PC where 2N<sup>®</sup> XAPI Server is running. In case 2N<sup>®</sup> XAPI Server is running on the same PC, add the local host IP address (127.0.0.1).

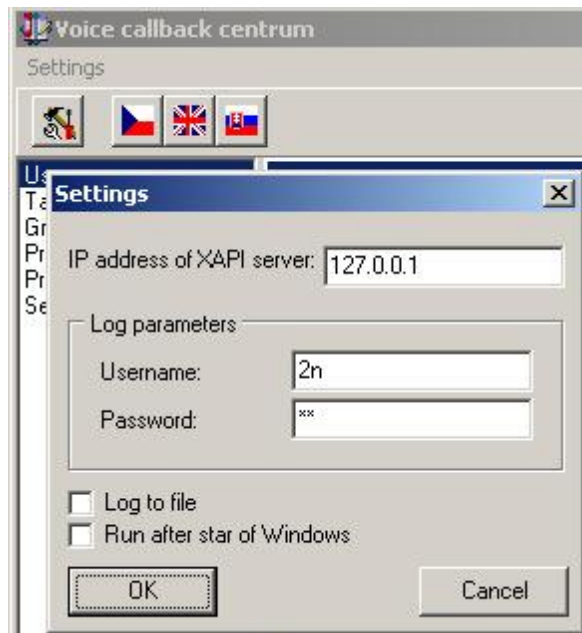

Once 2N<sup>®</sup> XAPI Server is correctly configured and access parameters are properly set, the Voice CallBack Centre software will automatically establish connection with 2N<sup>®</sup> XAPI Server.

To make sure, check the VCC LOG for the connection parameters and licence type.

```

04/06/16,11:05:57:**** Callback centre started.
04/06/16,11:05:58:**** Connecting XAPI server...
04/06/16,11:05:58:**** Waiting for answer...
04/06/16,11:05:58:**** Logging in...
04/06/16,11:05:58:**** XAPI ver 1.09 L (3CAE-D5C6)
04/06/16,11:05:58:**** STARGATE/BLUESTAR found on port 'EG1'. Activated!
04/06/16,11:05:58:**** Valid license found. Maximum number of users : 600.
XAPI ver 1.09 L (3CAE-D5C6)
  
```

## Configuration

### Add New User

In the Voice CallBack Centre you can add as many users as the 2N<sup>®</sup> XAPI Server licence enables. Set the CLIP (user phone identification) and name for each user. Moreover, assign each user a credit amount (tariff) for each group (destination). Automatic credit restoring can be activated/deactivated in the setting window. If you are adding a lot of new users, you can use tariff templates, which may be assigned to a new user. These templates are defined in the **Tariff templates** window.

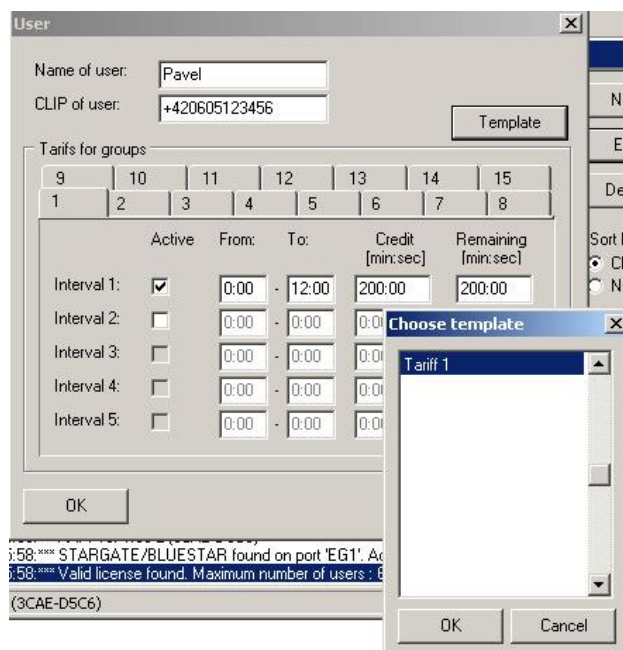

As shown in the example above, user Pavel has a phone number +420605215677 and credit rights for destination Group 1 only from midnight to noon. The month credit is 200 minutes. The user was created using the **Tariff 1** template.

## Tariff Templates

In this window you can prepare the **Customised tariffs**. These templates will help you add new users more quickly.

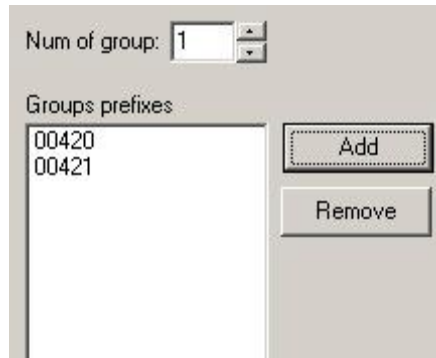

The screenshot shows a configuration window for tariff templates. At the top, there is a label 'Num of group:' followed by a text input field containing the number '1' and a small spinner control. Below this is a section titled 'Groups prefixes' which contains a list box with two entries: '00420' and '00421'. To the right of the list box are two buttons: 'Add' and 'Remove'.

## Groups

A table of prefixes. Each group contains real destination prefixes for calls (the number that the customer dials by DTMF). Each user can use a defined group (destination prefixes) only. The calls to the ISDN PRI / VoIP interface whose prefixes are restricted by the user settings or that are not defined in these tables are rejected!

## Prefixes to GSM

Currently not used, please do not change this table.

## Prefixes to ISDN

Currently not used, please do not change this table.

## Settings

Before using the Voice CallBack software, set the X10 parameter in the gateway as follows:

- Open the management software (e.g. PRIGW program);
- Establish connection with the gateway (over a serial interface or TCP/IP);
- Open **Terminal** in the **Gateway control** menu;
- write command **AT%X10=60** and press Enter.

If you sent the right command, the gateway responses OK.

Before using the Voice CallBack Centre, check the 2N web sites ([www.2n.cz](http://www.2n.cz)) for the latest 2N<sup>®</sup> XAPI Server and Voice CallBack Centre software versions.

# 4

## Advanced Configuration

This section contains description of the call data records and statistics generated by the 2N® StarGate / BlueStar / BlueTower gateway. A guide to the advanced gateway configuration using AT commands is also available.

Here is what you can find in this section:

- List of AT Commands
- List of Status Codes
- Trace
- List of LOG Events
- Statistics
- CDR Line Description

## 4.1 List of AT Commands

The protocol is derived from a standard AT protocol used for modems and GSM modules. The command format is AT[command]<CR>, or AT[command]<CR><LF> irrespective of the case. The response contains no or a few text lines, an empty line <CR><LF> and the response type: OK, ERROR or BUSY. To repeat the last command, enter A/<CR>.

### Basic Commands

#### System Information

**ATI3** Firmware version and copyright

**ATI4** Factory number

#### Statistics

**AT&T** Statistics of calls via PRI interface

**AT&TIN** Statistics of incoming calls via GSM modules

**AT&TOUT** Statistics of outgoing calls via GSM modules

**AT&T##** Statistics of calls via SIM cards of GSM module ##

**AT%TPR=mi,ci,mo,co** Setting of statistics via PRI

**AT%TG0=mi,ci,0,0** Setting of statistics of incoming calls via all GSM modules in GSM group 0

**AT%TG#=mi,co,ri,ro** Settings of statistics of GSM group #

**AT%TGALL=mo,co,ri,ro** Settings of statistics of all GSM groups

**AT%T##=#,mi,ci,si,mo,co,so** Settings of statistics of SIM card # of GSM module ##

**AT%T##=ALL,mi,ci,si,mo,co,so** Settings of statistics of all SIM cards of GSM module ##

**AT%TALL=ALL,mi,ci,si,mo,co,so** Settings of statistics of all SIM cards of all GSM modules

#### Description of parameters:

Mi/mo > Minutes of incom./outg. calls

Ci/co > number of connected incom./outg. calls

Ri/ro > number of re-routed incom/outg. calls in group

Si/so > number of received/sent SMS messages

**! When you change these parameters, all the other counters will be reset!!**

#### Wireless Engines

**AT&Q##** Received GSM signal level (##=00-15)

**AT&QALL** Received GSM signal level from all GSM modules

**AT&Gxx=atcmd** Send command for AT commands directly to GSM module

AT&Gxx=at+cnum – SIM card telephone number

AT&Gxx=at+cpin="xxxx" – PIN entering

AT&Gxx=at+clck="sc",1"xxxx" – PIN request enable

AT&Gxx=at+clck="sc",0"xxxx" – PIN request disable

#### LOG and CDR List

**AT&L** Log file listing (PRIGW awaits pressing of the Space bar after every 20 lines)

**AT&C** Call file listing (PRIGW awaits pressing of any key after every 20 lines)

**AT&CR** Call file listing and deleting (PRIGW awaits pressing of the # key to delete this line /with call info/ from memory and sends next line)

#### Configuration commands



**Status Information**

<b>AT&amp;V</b>	Overview of all system settings
<b>AT&amp;VI</b>	Overview of ISDN PRI settings
<b>AT&amp;V0</b>	Overview of basic GSM settings
<b>AT&amp;V#</b>	Overview of GSM group # settings (#=1-8)
<b>AT&amp;VALL</b>	Overview of all GSM group settings
<b>AT&amp;N#</b>	Overview of parameters of network list # (#=1-8)
<b>AT&amp;NALL</b>	Overview of parameters of all network lists
<b>AT&amp;R</b>	Overview of LCR lines

**Default Reset**

<b>AT&amp;FRES</b>	Reset with gateway factory settings
--------------------	-------------------------------------

**System Settings**

<b>AT%S70=x.x.x.x</b>	IP address
<b>AT%S71=x.x.x.x</b>	IP address mask
<b>AT%S81=</b>	Initialisation string for setting of mode connected to the gateway COM2
<b>AT%S90=x</b>	Type of assignment of B-channels to GSM modules (0-rotating; 1-locked; 2-according to credit)
<b>AT%S91=x,y</b>	Way of call information recording (0- no record; 1- successfully connected outgoing call; 2- successfully connected incoming calls; 3- successfully connected incoming and outgoing calls; 5- all outgoing calls; 6- all incoming calls; 7-all incoming+outgoing calls)  Y = to each call add NET info (1) or no (0)
<b>AT%S93=x</b>	Global selection of SIM card (0= according to GSM group, 1-8= number of SIM holder)
<b>AT%S98=xxxx</b>	PIN code for SIM cards inserted in the gateway
<b>AT%S99= dd.mm.yy.w/hh:mm:ss</b>	Gateway date and time settings
<b>AT%X00=hout,hin,min</b>	Automatic logout of GSM modules hout ...hour when the modules start to log out randomly hin ...hour when the modules start to log in randomly min ...minimum number of modules in a group (2..15) that always remain logged-in
<b>AT%X80=name/pass</b>	Username/password for access via IP port (this parameter is write only- you cannot see its value)

**System control**

<b>AT&amp;Bxx=DOWN</b>	Transfer of GSM board xx into the sleep mode
<b>AT&amp;BPR=DOWN</b>	Transfer of PRI board into the sleep mode
<b>AT&amp;BALL=DOWN</b>	Transfer of all GSM boards into the sleep mode
<b>AT&amp;Bxx=RESET</b>	Reset of GSM board xx
<b>AT&amp;BPR=RESET</b>	Reset of PRI board
<b>AT&amp;BALL=RESET</b>	Reset of all GSM boards
<b>AT&amp;BSYS=RESET</b>	Reset of PRIGW
<b>AT&amp;Gxx=RESET</b>	Reset of GSM module xx
<b>AT&amp;Gxx=BLOCK</b>	Block of GSM module xx
<b>AT&amp;Gxx=DOWN</b>	Transfer of GSM module into the sleep mode
<b>AT&amp;Gxx=ON</b>	Transfer of GSM module into the idle mode

**ISDN PRI Board**

<b>AT%I00=</b>	ISDN PRI port type (TE/S ; TE/M ; NT/S ; NT/M) or VoIP = SIP
<b>AT%I01=x,y</b>	X - TEI ISDN PRI connections (0-63) Y - CRC (0=off, 1=on)
<b>AT%I05=c1,c2,c3,c4</b>	Number of causes sent to ISDN PRI (in ReleaseComplete) whenever an incoming call from ISDN PRI is rejected
<b>AT%I11=</b>	MSN for remote control via PRI 1
<b>AT%I12=</b>	MSN for remote control via PRI 2
<b>AT%I04=x,y</b>	Channel select for PRI 1 / PRI 2
<b>AT%I06=c1,c2,c3,c4</b>	Progress messages
<b>AT%i09=day,bits,edb</b>	Day-day of reset statistics Bits - 0= no dial tone 1=continuous 3=discontinuous

### Basic GSM Settings

<b>AT%G00=rr,gggggg,gggggg,gggggg,gggggg,gggggg,gggggg</b>	g,r=Number of GSM group for each GSM module
<b>AT%G01=mode,atms,atfs</b>	Voice processing settings (for GM22 GSM modules only) mode - algorithm (0-none, 1-semiduplex, 2-fullduplex) atms,atfs - transit, receive gain (3=+5dB, 1=+2.5dB, 0=0dB, 2=-2.5dB, 4=-5dB)
<b>AT%G02=mode,atms,atfs</b>	Voice processing settings (for TC35 GSM modules only) mode - algorithm (2-echo canceller) atms,atfs - transit, receive gain (3=+5dBm, 1=+2.5dB, 0=0dB, 2=-2.5dB, 4=-5dB)
<b>AT%G06=mmdd,...mmdd...</b>	List of holiday days (mm-month;dd-day), max length of line is 63 chars!
<b>AT%G07=mmdd,...mmdd</b>	Net list of holiday days
<b>AT%G08=delay,min,max,tout</b>	Parameters of dialling from ISDN to GSM delay- relax delay between calls min - minimum length of number dialled from ISDN max - maximum length of number dialled from ISDN tout - delay between dialled digits

### GSM Settings (X-GSM Group)

<b>AT%G#0=sim</b>	Mode of switching SIM card sim> 0- OFF - group is turn-off 1-4 - SIM card 1-4 5 - switching by time 6 - switching by random time
<b>AT%G#1=netid,clir,min,sms,sec,sec2,pseudo</b>	Basic parameters of SIM card in slot 1 netid-network number clir - 0=default,1=enabled,2=disabled min - maximum number of minutes called sms - maximum number of SMS sent sec - minimum call length (not for cdr info) sec2 - accuracy of call length measurement (not for cdr info) pseudo - default = 0
<b>AT%G#2=netid,clir,min,sms,sec,sec2,pseudo</b>	Basic parameters of SIM card in slot 2
<b>AT%G#3=netid,clir,min,sms,sec,sec2,pseudo</b>	Basic parameters of SIM card in slot 3
<b>AT%G#4=netid,clir,min,sms,</b>	Basic parameters of SIM card in slot 4

**sec,sec2,pseudo**

<b>AT%G#5= from/to[/from,to/w+]</b>	Time intervals for using SIM card in slot 1, one or two intervals (from=to=hh:mm), w+(w-) parameter 'w+' (all weekend), or 'w-' (no weekend) for enabled/disabled SIM on weekends. In case AT%G#0=6 from/to= min/max limit for generating random time for SIM switching.
<b>AT%G#6= from/to[/from,to/w+]</b>	Time intervals for using SIM card in slot 2
<b>AT%G#7= from/to[/from,to/w+]</b>	Time intervals for using SIM card in slot 3
<b>AT%G#8= from/to[/from,to/w+]</b>	Time intervals for using SIM card in slot 4

**List of Networks**

<b>AT%N#0=op/np,...op/np</b>	List of prefixes replaced by new prefixes (#-number of netlist; op-old prefix;np-new prefix)
<b>AT%N#1=pr/n,...pr/n</b>	List of prefixes dialled into ISDN (to be used for LCR table) pr=prefix n=length of number (parameter /n is optional)
<b>AT%N#2..7=pr/n,...pr/n</b>	Other 7 lists of prefixes dialled into ISDN
<b>AT%N#9=net,max</b>	Net-network number, max-default length of number dialled from ISDN

**LCR Table**

<b>AT&amp;R</b>	Shows LCR table
<b>AT%R##=net,hh:mm/hh:mm/w*,gr</b>	Settings of line ## (0..63) of LCR table net – number of network list (0..8) hh:mm/hh:mm/w* – line using time limitation gr – GSM group numbers

**Test Calls**

<b>AT!SPxx=dial</b>	Initiates testing call from AUX interface (xx is the called interface): 1..15, 17-31 B-channel 32-rotating B-channel
<b>AT!SGxx=dial</b>	Initiates testing call from AUX interface (xx is the called interface): 00..31 GSM module 32- to GSM via GSM module according to call prefix
<b>AT!WPxx</b>	Connects the following call from interface xx to AUX interface 1..15, 17-31 from B-channel No. 32 first incoming calls from ISDN
<b>AT!WGxx</b>	Connects the following call from interface xx to AUX interface 00..31 from GSM No. 32 first incoming calls from GSM
<b>AT!D</b>	Terminates call on AUX interface

**Trace**

Trace can be activated for only one session at a time

<b>AT!RE</b>	Start tracing of error messages on active interface
<b>AT!Lx</b>	Start tracing of LAN & Telnet on layer x x=2 – Layers IP,TCP,Telnet x=3 – Layers TCP, Telnet x=4 – Layer Telnet
<b>AT!Rx</b>	Start tracing of ISDN PRI & GSM on layer x x=1 – Layers 1,2,3,4 x=2 – Layers 2,3,4 x=3 – Layers 3,4 x=4 – Layer 4

<b>AT!RR</b>	Start tracing (AT!R2) to COM1 interface
<b>AT!RX</b>	Stop tracing (AT!R2) to COM1 interface
<b>SMS Control</b>	SMS control can be activated for only one session at a time
<b>AT!G=#</b>	A6 – activate control via used session 55 – deactivate control via used session 99 – deactivate control on all sessions
<b>AT^MS=ch</b>	Module status ch=0 – 31
<b>*module: ch,sim,sts3,sts2,phs2,type</b>	Response to AT^MS: ch – number of wireless engine sim – number of currently used SIM: 0-none, 1-8-holder 1-8 sts3 – status of layer 3 sts2 – status of layer 2 phs2 – substatus of layer 2 type – type of wireless engine
<b>AT^MI=ch</b>	Module info ch = 0 -31
<b>*minfo: ch,sim,netid,"oper",new,cnt</b>	Response to AT^MI netid – network ID of active wireless network oper – name of active wireless network new – number of received and saved SMS on SIM card cnt – total number of sent SMS messages according to statistics
<b>*smsinc: ch,ix,sts,mem</b>	SMS message has been received and saved ix – index number of saved SMS (0-250) sts – status of SMS (from +CMGL: ix.sts.len) mem – type of used storage (1,2,3)
<b>*smsrep: ch,ix,sts,mem</b>	SMS status confirmation has been received sts – reserved (0)
<b>*smsout: ch[/id],ref,req</b>	SMS message was sent and not saved to SIM card Ref – reference number of SMS (0-255) – to be used in status confirmation messages ID – third party identification number of SMS
<b>*smspdu: ch,ix,sts,len,pdu,csum</b>	Content of SMS message len – length of SMS message (number of bytes in PDU) PDU – content of message in PDU format csum – checksum of all PDU bytes (2 hexa digits) calculated without carry
<b>*smsdel: ch,ix</b>	SMS message deletion confirmation
<b>*smserr: ch[/id],ix,req,err,cms</b>	Fault command response, or SMS not sent req – required wireless engine or GSM group err – error code (6-busy,40-write,41-read,42-delete,43-list) cms – error cause from wireless engine
<b>*smsssel: ch,cnt</b>	SMS storage change confirmation
<b>AT^SX=ch</b>	SMS listing - request for listing of all SMS messages and status confirmations saved on SIM card. Possible answers: *smserr (busy,list) or *smsinc (ix=1..255) for each saved SMS or status SMS , end of list or empty SIM card - *smsinc (ix=0).
<b>AT^SR=ch,ix</b>	SMS read - request for reading of an SMS message or SMS status saved on SIM card. Possible answers: *smserr (busy,read) or *smspdu
<b>AT^SD=ch,ix</b>	SMS delete - request for deletion of an SMS message (or SMS status message). Possible answers: *smserr (busy,delete) or *smsdel
<b>AT^SM=ch,len,pdu,chsum</b>	SMS to module - request for sending a message via GSM module 0..31 or via any GSM module (ch=32). Possible answers: *smserr (busy,write) or *smsout
<b>AT^SG=grp[/id],len,pdu,csum</b>	SMS to group - request for sending an SMS message via GSM group 1..8. Possible answers: *smserr (busy,write) or *smsout
<b>AT^SS=ch,mem</b>	Command for changing SMS storage. Mem (1;2;3) = type of SMS storage Siemens: 1=SM, 2=ME, 3=ME Ericsson: 1=SM, 2=ME, 3=ME Wavecom: 1=SM, 2=ME, 3=SR

---

Huawei:	1=SM, 2=SM, 3=SM
SierraWir.:	1=SM, 2=ME, 3=SR
Motorola:	1=IM, 2=IM, 3=IM

---

## 4.2 List of Status Codes

### Plug-In Boards

#### Board Types

Name	Description
<b>NONE</b>	(no board)
<b>CPU111</b>	(CPU board is not displayed)
<b>PRI 130</b>	1PRI port NT/TE board
<b>GSM160</b>	2GSM Ericsson GM22 module + 2SIM board
<b>AUX120</b>	Switch matrix + voice message generator + AUX port board
<b>GSM161</b>	2GSM Siemens TC35 module + 8SIM board

#### Board Types

Name	Description	What follows
<b>INIT</b>	HW board reset and init of respective SW parts in progress	OK/CHECK
<b>ERROR</b>	Board in wrong slot or defective board HW	board reset
<b>POWER</b>	Only upon system power on or AT!Bxx=RESET command	DETECT
<b>OK</b>	Rest status, HW is working on board (full operation)	DISC
<b>UNDEF</b>	Empty slot	DETECT
<b>CHECK</b>	Board firmware check (AUX only)	ERASE
<b>ERASE</b>	Board firmware erasing (AUX only)	PROF
<b>PROG</b>	New board firmware loading (AUX only)	OK
<b>DETECT</b>	New board plug-in detected	INIT
<b>DOWN</b>	Frozen status, HW is working on board but no new calls are started	board reset
<b>MODEMO</b>	Parameter S80 sent to modem (AUX only)	MODEM1
<b>MODEM1</b>	Parameter S81 sent to modem (AUX only)	OK
<b>DISC</b>	Board plug-out detected	UNDEF

### ISDN Layer Statuses

#### ISDN Layer 1

Name	Description
<b>DEACT</b>	Deactivation – no signal received
<b>ACTIVE</b>	Activation – full synchronisation achieved (frame,multiframe,crc)
<b>SIGNAL</b>	Signal received – no synchronisation
<b>SYNC</b>	Signal received – only partial synchronisation (frame)

**ISDN Layer 2**

Name	Name According to Q.921
<b>NOTEI</b>	TEI Unassigned
<b>AWTEI</b>	Assigned Awaiting TEI
<b>AWTEST</b>	Establish Awaiting TEI
<b>OKTEI</b>	TEI Assigned
<b>AWEST</b>	Awaiting Establishment
<b>AWREL</b>	Awaiting Release
<b>OKEST</b>	Multiple Frame Established
<b>TIMREC</b>	Timer Recovery

**ISDN Layer 3**

Name	Name According to Q.931	NT Description	TE Description
<b>NULL</b>	Null	Rest status, ready for call	
<b>CINIT</b>	Call Initiated	Call from PRI indicated	Call to PRI started
<b>OVSEND</b>	Overlap Sending	Gradual dialling receiving	Gradual dialling sending
<b>OPROC</b>	Outgoing Call Proceeding	Dialling from PRI terminated	Dialling to PRI terminated
<b>CDELIV</b>	Call Delivered	Call from PRI ringing	Call to PRI ringing
<b>CPRES</b>	Call Present	Call to PRI started	Call from PRI indicated
<b>CRECV</b>	Call Received	Call to PRI ringing	Call from PRI ringing
<b>CONREQ</b>	Connect Request	Call to PRI answered	Call from PRI answered
<b>IPROC</b>	Incoming Call Proceeding	Dialling to PRI terminated	Dialling from PRI terminated
<b>ACTIVE</b>	Active	Connected call	
<b>DISREQ</b>	Disconnect Request	End of call from PRI	End of call to PRI
<b>DISIND</b>	Disconnect Indication	End of call to PRI	End of call from PRI
<b>RELREQ</b>	Release Request	Channel release request	
<b>OVRECV</b>	Overlap Receiving	Gradual dialling sending	Gradual dialling receiving
<b>RSTREQ</b>	Restart Request	Channel restart request sent	
<b>RSTART</b>	Restart	Channel restart request received	

**ISDN Layer Management Statuses**

Name	Description
<b>INIT</b>	Initialisation upon PRI board reset
<b>IDLE</b>	Activation – rest status, necessary for layers 2 and 3
<b>DISC</b>	Deactivation

## GSM Layer Statuses

**GSM Layer 2**

Name	Description	What Follows
<b>INIT</b>	GSM module initialisation start	PINREQ
<b>SIMO</b>	Module switch to internal SIM card	INIT
<b>PINREQ</b>	Module PIN request	PINSET

<b>PINSET</b>	PIN value sending to module	INFO
<b>BLOCK</b>	Module blocked temporarily or permanently (see Layer 2 information)	INIT
<b>SETUP</b>	Module configuration running	IDLE
<b>SLEEP</b>	Module sleep running (transition to BLOCK status)	BLOCK
<b>NWAIT</b>	Awaiting GSM log-in	SETUP
<b>IDLE</b>	Rest status, can start/receive call, execute AT&G command	CALL/CMD
<b>CALL</b>	Call running (call establishing, connected call, call end)	IDLE
<b>CMD</b>	Communicating with module upon AT&G command	IDLE
<b>INFO</b>	Information loading from module and SIM card	NWAIT

### GSM Layer 2 Info for BLOCK

Name	Description
<b>(block)</b>	Blocked by AT&G command, terminated by module, board or system reset
<b>Netw-reg</b>	GSM log-in refused (not activated SIM), next attempt in 5..60 minutes
<b>Clir-err</b>	CLIR activation request refused, next attempt in 2..10 minutes
<b>Mod-err</b>	Defective or unconnected GSM module, next attempt in 2 minutes
<b>Pin-err</b>	Wrong PIN, permanently in BLOCK status
<b>Sim-err</b>	Defective or non- inserted SIM card, next attempt in 2 minutes
<b>Log-out</b>	Temporarily logged-out according to parameter X00
<b>Puk-req</b>	SIM card requires PUK
<b>(undef)</b>	This position of SIM card was not checked by gateway

### GSM Layer 3

Name	Description
<b>NULL</b>	Rest status, ready for call
<b>CINIT</b>	Request of call to GSM (from Layer 4)
<b>OPROC</b>	Call to GSM is connected
<b>CDELIV</b>	Call to GSM is ringing
<b>CPRES</b>	Indication of call from GSM (from Layer 2)
<b>CRECV</b>	Call from GSM is ringing on ISDN interface
<b>IPROC</b>	Call from GSM is processed by ISDN interface
<b>ACTIVE</b>	Connected call
<b>DISREQ</b>	Disconnection request (to Layer 2)
<b>DISIND</b>	Indication of disconnection (from Layer 2)
<b>RELREQ</b>	Module release for another call (to Layer 2)
<b>OVRECV</b>	Reading of DTMF dialling from GSM (from Layer 2)
<b>RELIND</b>	Indication of module release (from Layer2)

## Link Layer Statuses



**Layer 4**

Name	Description
<b>NULL</b>	Rest status, ready for call
<b>MORE</b>	Call request received from GSM or ISDN, awaiting further dialling or timeout
<b>SETUP</b>	Call request sent to opposite interface
<b>PROC</b>	Call request confirmed, awaiting call answer
<b>ACTIVE</b>	Connected call
<b>DISC</b>	Call disconnection in progress

## Command Shell Statuses

**Command Shell**

Name	Description
<b>IDLE</b>	Rest status, awaiting AT commands
<b>REQUEST</b>	Communication with GSM module upon AT&G command is displayed
<b>REPORT</b>	Active tracing
<b>LOGFILE</b>	Content of log file is being written out
<b>CALLFILE</b>	Content of call file is being written out
<b>CALLREAD</b>	Call file records are read
<b>AUTOFILE</b>	Content of incoming call auto routing chart is being written out
<b>QUERY</b>	(not used so far)
<b>SCREEN</b>	(not used so far)
<b>MATRIX</b>	Active matrix screensaver
<b>FUNCFILE</b>	Content of debug file is being written out
<b>LCRFILE</b>	(not used so far)

**Telnet Layer**

Name	Description
<b>LOGOUT</b>	User logged-out
<b>LOGIN</b>	User is entering name
<b>PASSW</b>	User is entering password
<b>IDLE</b>	User logged-in

## Records of Events and Calls

**Record Type in Log File**

Name	Description
<b>POWER</b>	System power on, power off or reset
<b>INIT</b>	Initialisation of EEPROM (configuration) or Flash (upgrade)
<b>HW-ERR</b>	HW error of plugged-in board

---

<b>SYSERR</b>	System error (memory error, etc.)
<b>BRDIN</b>	Board plugged-in
<b>BRDOUT</b>	Board plugged-out
<b>BRDRES</b>	Board reset using AT!B command
<b>L1-ERR</b>	PRI port layer 1 error (ISDN1)
<b>L2-ERR</b>	PRI port layer 2 error (ISDN2)
<b>L3-ERR</b>	PRI port layer 3 error (ISDN3)
<b>G2-ERR</b>	GSM module layer 2 error (gate2)
<b>G3-ERR</b>	GSM module layer 3 error (gate3)
<b>C4-ERR</b>	Link layer error (call4)

---

#### Record Type in Call File

Name	Description
<b>I-FD</b>	Unconnected incoming call attempt
<b>I-OK</b>	Connected incoming call
<b>O-FD</b>	Unconnected outgoing call attempt
<b>O-OK</b>	Connected outgoing call

---

## 4.3 Trace

With tracing activated, the internal system messages (transmitted between processes), messages received on and sent to the PRI / VoIP ports, and AT commands and replies sent to GSM modules are written out. The listing of a message related to a specific call starts with the B-channel and GSM module numbers and an arrow showing the message direction. The right arrow (→) means a message received on an interface (PRI, GSM, LAN) or a message directed from a lower layer process to a higher layer process (indication, confirmation). The left arrow (←) designates a message sent to an interface (PRI, GSM, LAN) or a message directed from a lower layer process to a higher layer process (request, response). The message type (layer 3 messages are shifted by a space to the right, layer 4 messages by two spaces to the right) and the message content follow.

### ISDN Messages

---

#### Typically Used ISDN Messages (Q.931)

<b>!alertin</b>	Alerting
<b>!callproc</b>	Call proceeding
<b>!progress</b>	Progress
<b>!setup</b>	Setup
<b>!connect</b>	Connect
<b>!setack</b>	Setup acknowledge
<b>!connack</b>	Connect acknowledge
<b>!disconn</b>	Disconnect
<b>!restart</b>	Restart
<b>!release</b>	Release
<b>!restack</b>	Restart acknowledge
<b>!relcompl</b>	Release complete
<b>!facility</b>	Facility
<b>!notify</b>	Notify
<b>!stsenq</b>	Status enquiry
<b>!info</b>	Information
<b>!status</b>	Status

#### Typically Used ISDN Elements - Cause (Q.850)

ID	Name	Whole name
1	<b>Unassnumb</b>	Unassigned number
6	<b>Unaccchan</b>	Channel unacceptable
16	<b>Clear</b>	Normal call clearing
17	<b>Userbusy</b>	User busy
21	<b>Reject</b>	Call rejected

---

27	<b>Destout</b>	Destination out of order
28	<b>Invformat</b>	Invalid number format
30	<b>Stsenqresp</b>	Response to StatusEnquiry
31	<b>Normal</b>	Normal, unspecified
34	<b>Noanychan</b>	No channel available
41	<b>Tempfail</b>	Temporary failure
42	<b>Swcongest</b>	Switching equipment congestion
44	<b>Noreqchan</b>	Requested channel not available
65	<b>Nobearer</b>	Bearer capability not implemented
81	<b>Callref</b>	Invalid call reference value
88	<b>Dest</b>	Incompatible destination
96	<b>Elemmiss</b>	Mandatory information element is missing
97	<b>Message</b>	Message type non-existent or unimplemented
99	<b>Element</b>	Information element / parameter non-existent or unimplemented
100	<b>Elemerror</b>	Invalid information element contents
101	<b>Incmess</b>	Message incompatible with call state
102	<b>Timeout</b>	Recovery on timer expiry
127	<b>Undefined</b>	Interworking, unspecified

---

## 4.4 List of LOG Events

Type	Text	Description
<b>POWER</b>	[Power on]	System switched on
	[Power off]	System switched off
	[Warm boot]	Restart of system, unknown cause
	[Watchdog]	Restart of system by watchdog
	[BKPT code]	CPU error: break code detected
	[Stack error]	CPU error: stack integrity failure
	[Divided by zero]	CPU error: dividing by zero
	[RETI code]	CPU error: illegal using of instruction reti
	[NMI intr]	CPU error: wrong interrupt
	[VOID intr]	CPU error: wrong interrupt
	[Upgrade reset]	Start of upgrade firmware procedure
[Software reset]	Reset by AT commands (at&fres...)	
<b>INIT</b>	Eeprom	Initialisation of eeprom (configuration)
	Flash	Initialisation of flash memory (firmware)
<b>HW-ERR</b>		(##...address of chip, RD...read value WR...expected value)
	Codec ##,RD/WR	Error in initialisation of codec on GSM,AUX board
	COM2 #####,RD/WR	Error in initialisation of COM2 on AUX board
	Duart #####,RD/WR	Error in initialisation of serial controller on GSM board
	Hscx #####,RD/WR	Error in initialisation of HDLC controller on AUX board
	Pri #####,RD/WR	Error in initialisation of PRI controller
<b>SYSEERR</b>	User stack error!	SW error: stack integrity failure
<b>BRDIN</b>	#08 TYP STS	Board inserted (number of gsm board, type, status)
<b>BRDOUT</b>	#08 TYP STS	Board disconnected
<b>BRDRES</b>	#08 TYP STS	Reset the board by AT command
	ALL GSM RESET CMD	Reset all GSM boards by AT command
	SYSTEM RESET CMD	Reset the system by at&sys command
<b>L1-ERR</b>		(reserved)
<b>L2-ERR</b>		Error of ISDN layer 2 by Q.921
	A: unsol.RX(F)	Received packet RR,RNR,REJ with unexpected bit F=1
	B: unsol.DM(F)	Received packet DM with unexpected bit F=1
	C: unsol.UA(F)	Received packet UA with unexpected bit F=1
	D: unsol.UA(-)	Received packet UA with unexpected bit F=0
	E: unsol.DM(-)	Received packet DM with unexpected bit F=0
	F: peer re-est	Received packet SABME in status OKEST
	G: repeated SABME	Repeated unsuccessful send of packet SABME
	H: repeated DM	Repeated unsuccessful send of packet DM
	I: failed (TIMREC)	Unsuccessful breaking-up of status TIMREC
	J: N(R) error	Received wrong value N(R) – numbering of packets

---

	K: recv.FRMR	Received packet FRMR (information about error)
	L: undef.frame	Received packet of unknown type
	M: (I field)	Received wrong I-packet (numbered packet)
	N: frame size	Received packet with wrong length
	O: N201 error	Value N201 was exceeded (max length of packet)
<b>L3-ERR</b>	tout sts # (p##)	Error of isdn layer 3: timeout in status # on channel p##
<b>G2-ERR</b>	ATD/ERROR init (g##)	Error of isdn layer 2: restart of module g## after rejected command ATD by GSM network
	GSM Cause 150 (g##)	Error of isdn layer 2: restart of module g## after cause 150 was received (call barred by GSM network)
<b>G3-ERR</b>	tout sts # (g##)	Error of isdn layer 3: timeout in status # on module g##
<b>C4-ERR</b>	tout sts # (p##/g##)	Error of connecting layer 4: timeout in status # on call between channel p## and GSM module g##

---

# 4.5 Statistics

**[Statistic of calls on PRI and in groups ]**

pri/grp (reset)	minutes	hhhh:mm:ss	calls	reject	failed	c.off	errors
#pr out (1.03)	1303	21:43:07	521	1	24	147	2
#pr inc (1.03)	41	0:41:28	24	0	6	1	0

**[Statistic of calls on PRI and in groups]**

gsm (reset)	minutes	hhhh:mm:ss	calls	reject	failed	c.off	errors
#i1 inc (31.12)	0	0:00:00	0	0	0	0	0
#i2 inc (31.12)	0	0:00:00	0	0	0	0	0
#i3 inc (31.12)	0	0:00:00	0	0	0	0	0
#i4 inc (31.12)	0	0:00:00	0	0	0	0	0

gsm (reset)	minutes	hhhh:mm:ss	calls	reject	failed	red.in	redout
#g1 out (31.12)	0	0:00:00	0	0	0	0	0
#g2 out (31.12)	0	0:00:00	0	0	0	0	0
#g3 out (31.12)	0	0:00:00	0	0	0	0	0
#g4 out (31.12)	0	0:00:00	0	0	0	0	0
#g5 out (31.12)	0	0:00:00	0	0	0	0	0
#g6 out (31.12)	0	0:00:00	0	0	0	0	0
#g7 out (31.12)	0	0:00:00	0	0	0	0	0
#g8 out (31.12)	0	0:00:00	0	0	0	0	0

**[ Statistic of incoming calls on all modules ]**

modules	brd	minutes	hhhh:mm:ss	calls	sms	minutes	hhhh:mm:ss	calls	sms
#00 #01	00	0	0:00:00	0	0	0	0:00:00	0	0
#02 #03	01	0	0:00:44	1	0	16	0:16:37	10	0
#04 #05	02	14	0:14:15	7	0	5	0:05:31	3	0
#06 #07	03	4	0:04:21	3	0	0	0:00:00	0	0
#08 #09	04	0	0:00:00	0	0	0	0:00:00	0	0
#10 #11	05	0	0:00:00	0	0	0	0:00:00	0	0
#12 #13	06	0	0:00:00	0	0	0	0:00:00	0	0

\*each line is for two wireless modules

**[ Statistic of calls on GSM module #0 ]**

sim/dir	net/grp	minutes	hhhh:mm:ss	calls	reject	failed	c.off	sms
#1 inc	/1	14	0:14:15	7	0	2	9	0
#2 inc	/1	0	0:00:00	0	0	0	0	0
#3 inc	/1	0	0:00:00	0	0	0	0	0
#4 inc	/1	0	0:00:00	0	0	0	0	0
#1 out	/1	439	7:19:51	177	0	6	44	0
#2 out	/1	0	0:00:00	0	0	0	0	0
#3 out	/1	0	0:00:00	0	0	0	0	0
#4 out	/1	0	0:00:00	0	0	0	0	0

Pri/grp : type of calls

Reset : date of last reset the statistics

Minutes : number of minutes

Hhhh:mm:ss : same number converted to time

Calls : number of calls

SMS : number of sent SMS messages

Reject: number of unconnected calls (no available free GSM module-call rejected with cause 41(42))

Failed: number of unconnected calls (rejected by GSM network)

C.off: number of unconnected calls (terminated by calling party)

Errors: number of unconnected calls (wrong requests - disallowed prefix, etc.)

Red.in: number of connected calls (rerouted to this GSM group)

Redout: number of connected calls (rerouted to another GSM group)

## 4.6 CDR Line Description

\*\* 31.07.02/11:07:53 O-OK CAU-016 aux/g02 GRP-1 0:23 001:40 00000.00 1 0608218005 45456060 1/8942019636000065750

- Column 1: \*\*
- Column 2: date/time of call start
- Column 3: type of call
- Column 4: CAUSE sent to ISDN
- Column 5: number of used B-channel/number of used GSM module
- Column 6: used GSM group (C= CallBack to PRI 1 , E= call via PRI 2 interface)
- Column 7: call setup time
- Column 8: call duration in mmm:ss (max 255:59) or error cause for unconnected calls
- Column 9: call cost (will be implemented in a higher firmware version)
- Column 10 : gateway id (optional)
- Column 11: called number
- Column 12: calling number
- Column 13: slot number/IMSI\* of used SIM card



# 5

## Technical Parameters

This section provides technical conditions for the 2N<sup>®</sup> StarGate / BlueStar / BlueTower installation.

- StarGate Technical Parameters
- BlueStar Technical Parameters
- BlueTower Technical Parameters



## 5.1 StarGate Technical Parameters

### Subrack

Dimensions (W x H x D)	482 x 133 x 360 mm (84HP x 3U x 360 mm)
Weight (full configuration)	9,800 g
Power supply	100-240V AC / 50-60Hz, or 48 DC
Power input	max 230VA

### GSM / UMTS

Mobile network type	GSM phase II or UMTS
Transmission output per channel	900MHz / 2W, 1800MHz / 1W or 850MHz / 2W, 1900MHz / 1W or 850MHz / 1900MHz / 2100MHz UMTS
SIM cards	Plug-in small <b>3V</b>
VF connector	GSM boards with TC35i,MC55i,Q55 UMTS boards with MC8790V module connector – SMA 50ohm
Antenna splitter	Only external models

### PRI Interface(s)

Interface	1PRI or 2ISDN PRI
Frame	E1
CRC	Supported
Signalling	Q.931-EDSS1
Type (NT or TE)	Switchable NT or TE
TEI number	0 – 63
Clock (master or slave)	Master/Slave
Connector RJ 45, Rxpin, Txpin	Switchable RJ45 (Rx-3,6 Tx-4,5 / Rx-4,5 Tx-3,6)
D channel timeslot	30

### VoIP interface

Interface	Switch 4x 10/100BaseT
Signalling	SIP
Voice compression	G.723.1 MP-MLQ at 6.3, ACELP at 5.3 kbps G.729 Annex A CS-ACELP at 8kbps G.711 PCM at 64kbps (u-Law/A-Law)
Number of voice channels	16
Connector type	4 RJ45 (Ethernet switch)

## Temperature

---

Working temperature range	0°C to + 40°C
Relative humidity	max 95% at 40°C
Air – condition	Recommended

---

## Remote Control Line Types

---

Type of line	Serial line (COM1,2) Analogue modem (COM2) ISDN modem (COM2) Ethernet 10baseT - Telnet ISDN PRI (PRI 1, PRI 2) Web interface – HTTP (eCPU)
--------------	---

---

## 5.2 BlueStar Technical Parameters

### Subrack

Dimensions (W x H x D)	482 x 133 x 360 mm (84HP x 3U x 360 mm)
Weight (full configuration)	9,800 g
Power supply	100-240V AC / 50-60Hz, or 48 DC
Power input	max 230VA

### GSM / UMTS

Mobile network type	GSM phase II or UMTS
Transmission output per channel	900MHz / 2W, 1800MHz / 1W or 850MHz / 2W, 1900MHz / 1W or 850MHz / 1900MHz / 2100MHz UMTS
SIM cards	Plug-in small <b>3V</b>
VF connector	GSM boards with TC35i,MC55i,Q55 UMTS boards with MC8790V module connector – SMA 50ohm
Antenna splitter	Internal 16/1, or 16/2

### PRI Interface(s)

Interface	1PRI or 2ISDN PRI
Frame	E1
CRC	Supported
Signalling	Q.931-EDSS1
Type (NT or TE)	Switchable NT or TE
TEI number	0 – 63
Clock (master or slave)	Master/Slave
Connector RJ 45, Rxpin, Txpin	Switchable RJ45 (Rx-3,6 Tx-4,5 / Rx-4,5 Tx-3,6)
D channel timeslot	16

### VoIP interface

Interface	Switch 4x 10/100BaseT
Signalling	SIP
Voice compression	G.723.1 MP-MLQ at 6.3, ACELP at 5.3 kbps G.729 Annex A CS-ACELP at 8kbps G.711 PCM at 64kbps (u-Law/A-Law)
Number of voice channels	16
Connector type	4 RJ45 (Ethernet switch)

## Temperature

---

Working temperature range	0°C to + 40°C
Relative humidity	max 95% at 40°C
Air – condition	Recommended

---

## Remote Control Line Types

---

Type of line	Serial line (COM1,2) Analogue modem (COM2) ISDN modem (COM2) Ethernet 10baseT - Telnet ISDN PRI (PRI 1, PRI 2) Web interface – HTTP (eCPU)
--------------	---

---

## 5.3 BlueTower Technical Parameters

### Rack

Dimensions (W x H x D)	160 x 185 x 320 mm (29HP x 3U x 320 mm)
Weight (full configuration)	4,1 kg
Power supply	100-240V AC / 50-60Hz
Power input	max 50VA

### GSM / UMTS

Mobile network type	GSM phase II or UMTS
Transmission output per channel	900MHz / 2W, 1800MHz / 1W or 850MHz / 2W, 1900MHz / 1W or 850MHz / 1900MHz / 2100MHz UMTS
SIM cards	Plug-in small <b>3V</b>
VF connector	GSM boards with TC35i,MC55i,Q55 UMTS boards with MC8790V module connector – SMA 50ohm
Antenna splitter	Only external

### PRI Interface(s)

Interface	1PRI or 2ISDN PRI
Frame	E1
CRC	Supported
Signalling	Q.931-EDSS1
Type (NT or TE)	Switchable NT or TE
TEI number	0 – 63
Clock (master or slave)	Master/Slave
Connector RJ 45, Rxpin, Txpin	Switchable RJ45 (Rx-3,6 Tx-4,5 / Rx-4,5 Tx-3,6)
D channel timeslot	16

### VoIP interface

Interface	Switch 4x 10/100BaseT
Signalling	SIP
Voice compression	G.723.1 MP-MLQ at 6.3, ACELP at 5.3 kbps G.729 Annex A CS-ACELP at 8kbps G.711 PCM at 64kbps (u-Law/A-Law)
Number of voice channels	8
Connector type	4x RJ45 (Ethernet switch)

## Temperature

---

Working temperature range	0°C to + 50°C
Relative humidity	max 95% at 40°C
Air – condition	Recommended

---

## Remote Control Line Types

---

Type of line	Serial line (COM1,2) Analogue modem (COM2) ISDN modem (COM2) Ethernet 10baseT - Telnet ISDN PRI (PRI 1, PRI 2) Web interface – HTTP (eCPU)
--------------	---

---



# 6

## Supplementary Information

This section provides supplementary information on the product.

Here is what you can find in this section:

- Regulations and Directives
- Troubleshooting
- List of Abbreviations
- General Instructions and Cautions

## 6.1 Regulations and Directives

2N<sup>®</sup> StarGate/BlueStar/BlueTower conforms to the following directives and regulations:

- Directive 1999/5/EC of the European Parliament and of the Council, of 9 March 1999 – on radio equipment and telecommunications terminal equipment and the mutual recognition of their conformity
- Directive 2006/95/EC of the European Parliament and of the Council of 12 December 2006 on the harmonisation of the laws of the Member States relating to electrical equipment designed for use within certain voltage limits
- Directive 2004/108/EC of the European Parliament and of the Council of 15 December 2004 on the approximation of the laws of the Member States relating to electromagnetic compatibility and repealing Directive 89/336/EEC
- Directive 2002/96/EC of the European Parliament and of the Council of 27 January 2003 on waste electrical and electronic equipment
- Regulation (EC) No 1907/2006 of the European Parliament and of the Council of 18 December 2006 concerning the Registration, Evaluation, Authorisation and Restriction of Chemicals (REACH), establishing a European Chemicals Agency, amending Directive 1999/45/EC and repealing Council Regulation (EEC) No 793/93 and Commission Regulation (EC) No 1488/94 as well as Council Directive 76/769/EEC and Commission Directives 91/155/EEC, 93/67/EEC, 93/105/EC and 2000/21/EC
- Directive 2002/95/EC of the European Parliament and of the Council of 27 January 2003 on the restriction of the use of certain hazardous substances in electrical and electronic equipment

# 6.2 Troubleshooting

## PRI-to-VoIP System Switch

You have to say YES to ALL of the following questions to make the attached VoIP card work properly:

When you remove all cards from the gateway, do you have 6 jumpers placed between positions 3 and 4 (counting from the right)?	<b>YES</b>	<b>NO</b>
Are all the jumpers set according to Figure 1?	<b>YES</b>	<b>NO</b>
Are all the main cards (CPU, VoIP, AUX) placed according to Fig. 2?	<b>YES</b>	<b>NO</b>
Does the CPU card contain bootware version 2.52?	<b>YES</b>	<b>NO</b>
Does the CPU card contain firmware version 2.30.01 or higher? *	<b>YES</b>	<b>NO</b>
Does the CPU contain firmware for a new VoIP card? *	<b>YES</b>	<b>NO</b>
Does the response to ATI4 command (from the CPU card) contain line "DspAddr:" with value not equal to 00-00-00-00-00-00? **	<b>YES</b>	<b>NO</b>
Is the gateway mode set to SIP (System parameters section)?	<b>YES</b>	<b>NO</b>
Is the VoIP card/MGCP gateway parameter set to correct IP?	<b>YES</b>	<b>NO</b>
Is it possible to make calls using your gateway?	<b>YES</b>	<b>NO</b>

\* can be upgraded/loaded by the PRI configuration program version 1.1m or higher.

\*\* can be changed with the help of the 2N Technical Support.

**IF YOU SUCCESSFULLY ANSWERED YES TO ALL THE QUESTIONS MENTIONED ABOVE, YOU CAN INSTALL THE ATTACHED VOIP CARD INTO YOUR PRI GATEWAY SYSTEM. CONGRATULATIONS!**

In case you answered NO to one or more questions, please try to (in this order):

- find a solution on the 2N FAQ pages (<https://jira.2n.cz/confluence/pages/viewpage.action?pagelId=1605793>);
- download the latest version of the full user manual for your PRI gateway;
- contact the 2N Technical Support ( [support@2n.cz](mailto:support@2n.cz) ).

FIGURE (1)	FIGURE (2)
------------	------------

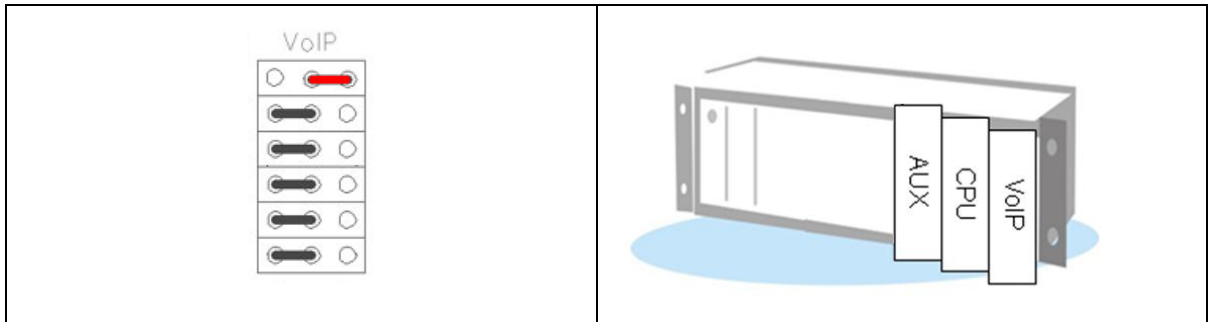

## FAQ



For tips concerning solutions of other potential problems see [faq.2n.cz](http://faq.2n.cz).

For the recent FAQ refer to the 2N FAQ pages:  
(<https://jira.2n.cz/confluence/pages/viewpage.action?pageId=1605793>).

- ❓ *Calls to GSM / UMTS still go over the PRI 2 interface*
  - ◆ The prefix you are calling is not included in any prefix list.
  - ◆ There is no rule in the LCR table connecting this prefix list with at least one GSM outgoing group.
  - ◆ The call type is not voice (FAX, DATA).
  - ◆ The used voice codec is uLaw (the gateway supports aLaw only).
- ❓ *SMS at no answer does not contain the **Calling party number***
  - ◆ The **Text of SMS at no answer** parameter must contain **%n**, which represents the calling party number.
- ❓ *The Init LED is flashing on the GSM / UMTS board*
  - ◆ You are using a GSM / UMTS card from a different type of gateway (for example, you are using a 2N<sup>®</sup> BlueStar card in 2N<sup>®</sup> StarGate).

## 6.3 List of Abbreviations

- **APN**  
Access Point Name – necessary for the GPRS service
- **CLIP**  
Calling Line Identification Presentation
- **CSD**  
Circuit Switched Data
- **COM**  
PC serial port
- **DTMF**  
Dual Tone Multi Frequency - tone dialling
- **EG**  
StarGate/BlueStar/BlueTower
- **FSK**  
Frequency Shift Keying
- **FXO**  
an interface electrically identical with a standard telephone (opposite side = FXS interface)
- **FXS**  
a telephone interface allowing standard telephone connection (opposite side = FXO interface)
- **FW**  
Firmware - similar to SW, a term for the central microprocessor program
- **GSM**  
Group Switched Mobile system - the present standard digital mobile telephone network
- **GPRS**  
General Packet Radio Service - high-speed data transmission for GSM networks
- **HW**  
Hardware - an electronic device, circuit, board, component, etc. in this context
- **P(A)BX**  
Private (Automatic) Branch Exchange
- **PC**  
Personal Computer (based on the IBM PC standard)
- **PIN**  
Personal Identification Number - a SIM card securing password
- **PUK**  
Personal Unblocking Key - a password used to unblock a blocked SIM card after repeated wrong PIN entering
- **RS-232C**  
a PC serial port standard

- **SIM**  
Subscriber Identity Module - a chip-equipped module to be inserted in a GSM device for identification
- **SMS**  
Short Message Service, a term for the system and one unit (message)
- **SW**  
Software
- **TTL**  
Transistor-Transistor Logic - a standard digital technology defining voltage for levels 0 and 1
- **PSTN**  
Public Switched Telephone Network

## 6.4 General Instructions and Cautions

Please read this User Manual carefully before using the product. Follow all instructions and recommendations included herein.

Any use of the product that is in contradiction with the instructions provided herein may result in malfunction, damage or destruction of the product.

The manufacturer shall not be liable and responsible for any damage incurred as a result of a use of the product other than that included herein, namely undue application and disobedience of the recommendations and warnings in contradiction herewith.

Any use or connection of the product other than those included herein shall be considered undue and the manufacturer shall not be liable for any consequences arisen as a result of such misconduct.

Moreover, the manufacturer shall not be liable for any damage or destruction of the product incurred as a result of misplacement, incompetent installation and/or undue operation and use of the product in contradiction herewith.

The manufacturer assumes no responsibility for any malfunction, damage or destruction of the product caused by incompetent replacement of parts or due to the use of reproduction parts or components.

The manufacturer shall not be liable and responsible for any loss or damage incurred as a result of a natural disaster or any other unfavourable natural condition.

The manufacturer shall not be held liable for any damage of the product arising during the shipping thereof.

The manufacturer shall not make any warrant with regard to data loss or damage.

The manufacturer shall not be liable and responsible for any direct or indirect damage incurred as a result of a use of the product in contradiction herewith or a failure of the product due to a use in contradiction herewith.

All applicable legal regulations concerning the product's installation and use as well as provisions of technical standards on electric installations have to be obeyed. The manufacturer shall not be liable and responsible for damage or destruction of the product or damage incurred by the consumer in case the product is used and handled contrary to the said regulations and provisions.

The consumer shall, at its own expense, obtain software protection of the product. The manufacturer shall not be held liable and responsible for any damage incurred as a result of the use of deficient or substandard security software.

The consumer shall, without delay, change the access password for the product after installation. The manufacturer shall not be held liable or responsible for any damage incurred by the consumer in connection with the use of the original password.

The manufacturer also assumes no responsibility for additional costs incurred by the consumer as a result of making calls using a line with an increased tariff.

## Electric Waste and Used Battery Pack Handling

---



Do not place used electric devices and battery packs into municipal waste containers. An undue disposal thereof might impair the environment!

Deliver your expired electric appliances and battery packs removed from them to dedicated dumpsites or containers or give them back to the dealer or manufacturer for environmental-friendly disposal. The dealer or manufacturer shall take the product back free of charge and without requiring another purchase. Make sure that the devices to be disposed of are complete.

Do not throw battery packs into fire. Battery packs may not be taken into parts or short-circuited either.





2N TELEKOMUNIKACE a.s.

Modřanská 621, 143 01 Prague 4, Czech Republic  
Tel.: +420 261 301 500, Fax: +420 261 301 599  
E-mail: [sales@2n.cz](mailto:sales@2n.cz)  
Web: [www.2n.cz](http://www.2n.cz)